

Clipping Polygons

Dr. Scott Schaefer

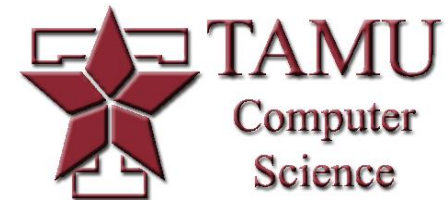

Clipping Polygons

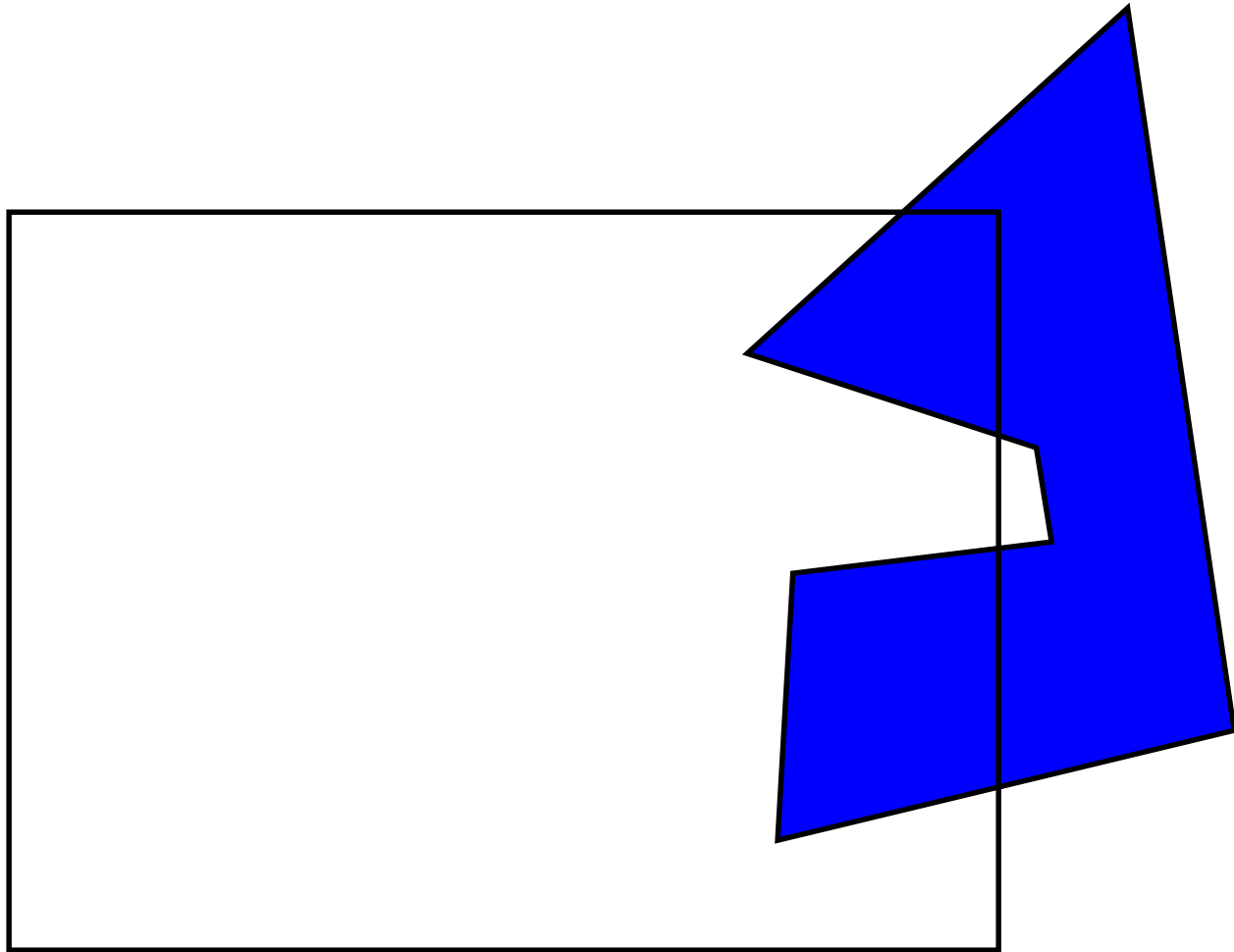

Clipping Polygons

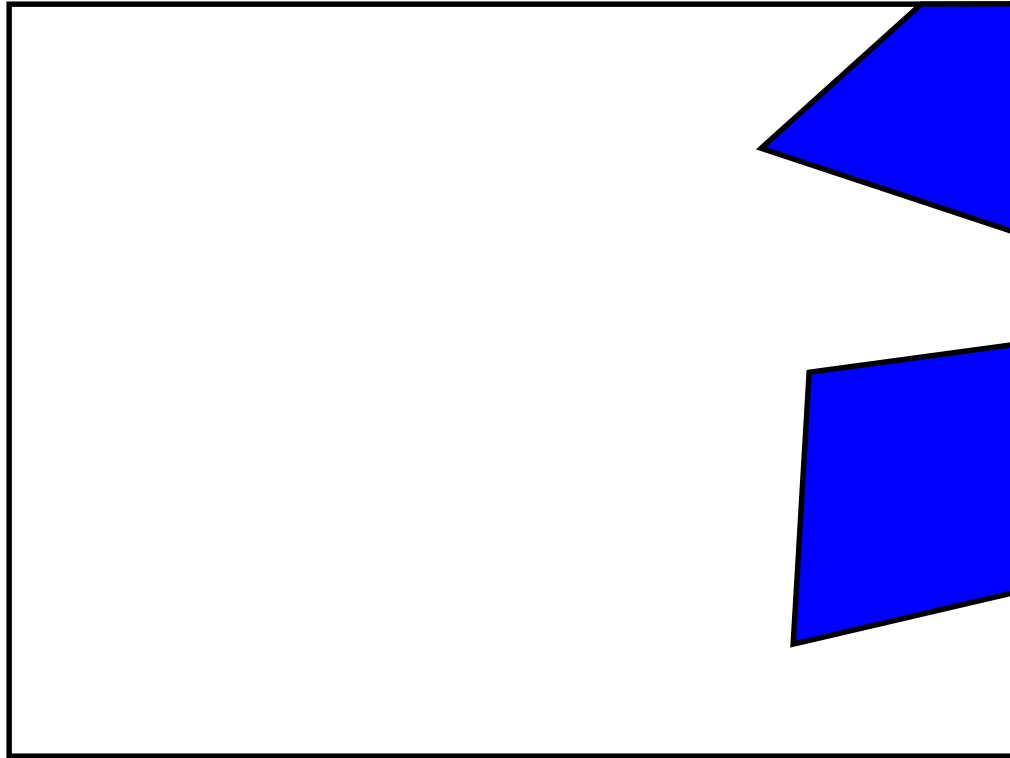

Why Is Polygon Clipping Hard?

- What happens to a triangle during clipping?
 - possible outcomes:

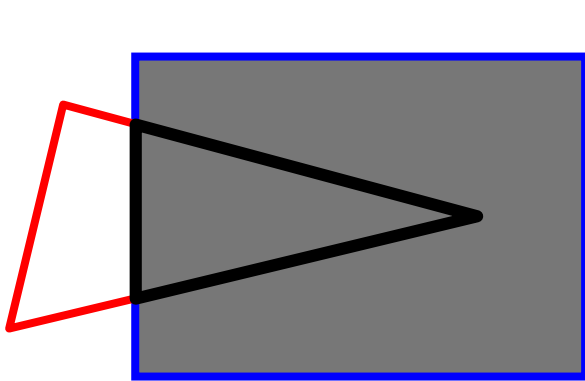

triangle → triangle

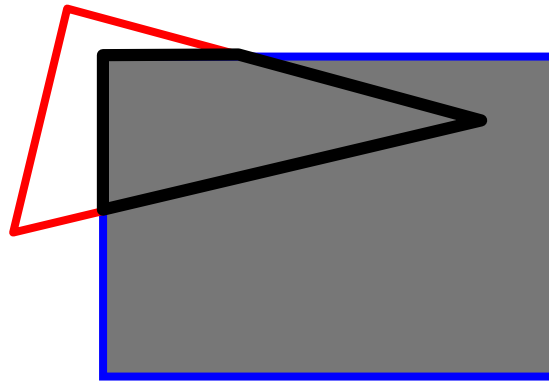

triangle → quad

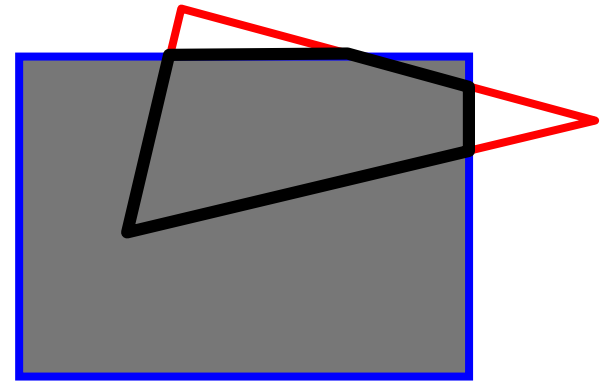

triangle → 5-gon

Why Is Polygon Clipping Hard?

- What happens to a triangle during clipping?
 - possible outcomes:

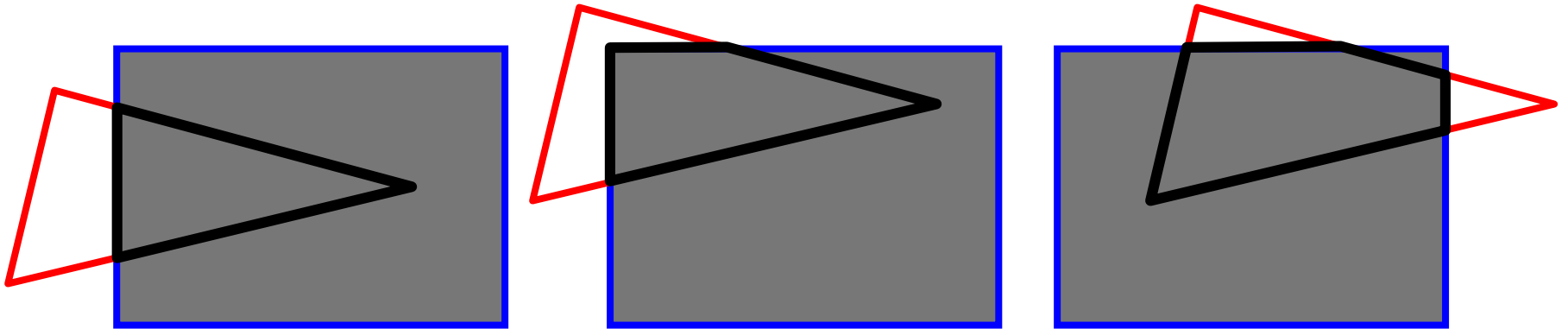

triangle → triangle

triangle → quad

triangle → 5-gon

How many sides could a clipped triangle have?

How Many Sides?

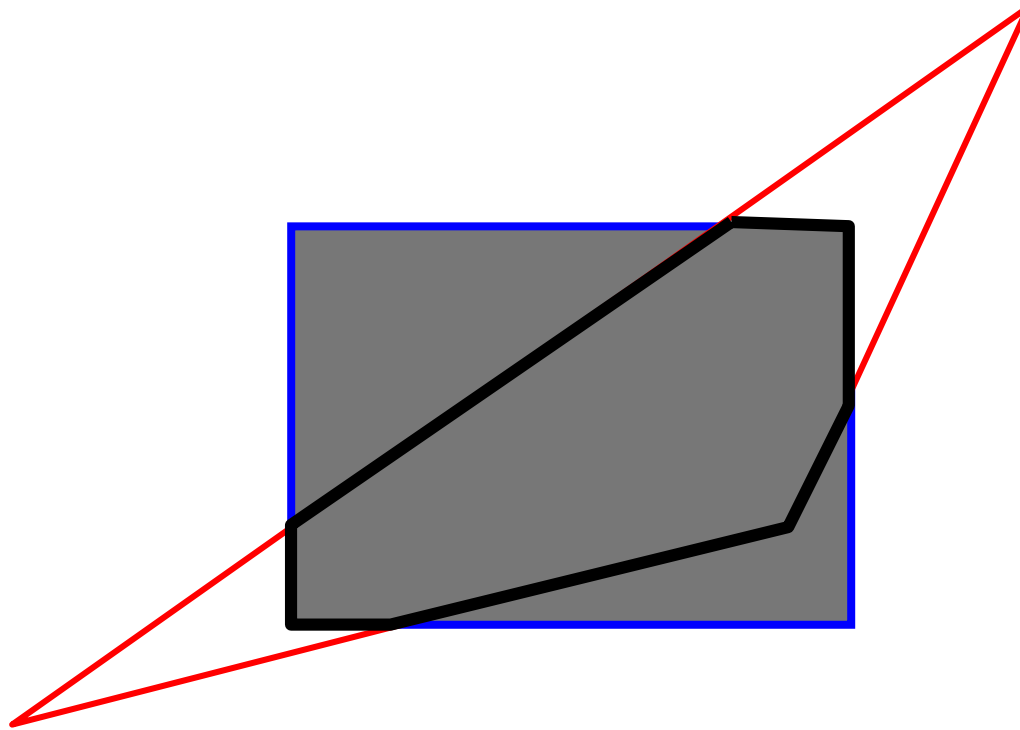

7

Why Is Polygon Clipping Hard?

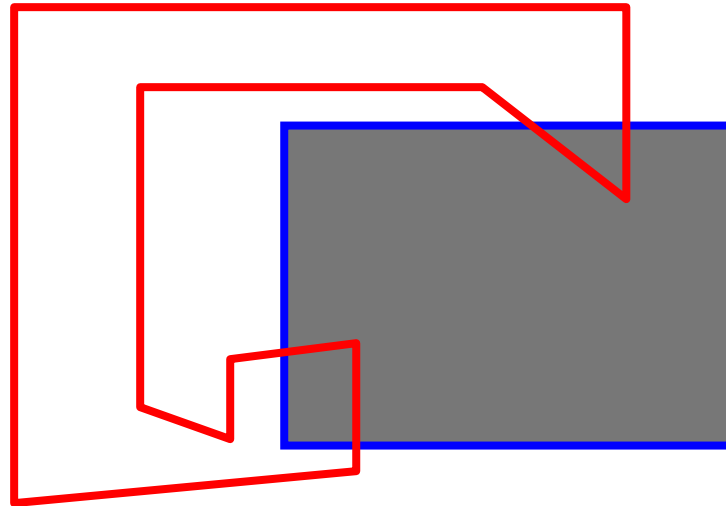

Concave polygon \rightarrow Multiple polygons

Why Is Polygon Clipping Hard?

- A really tough case

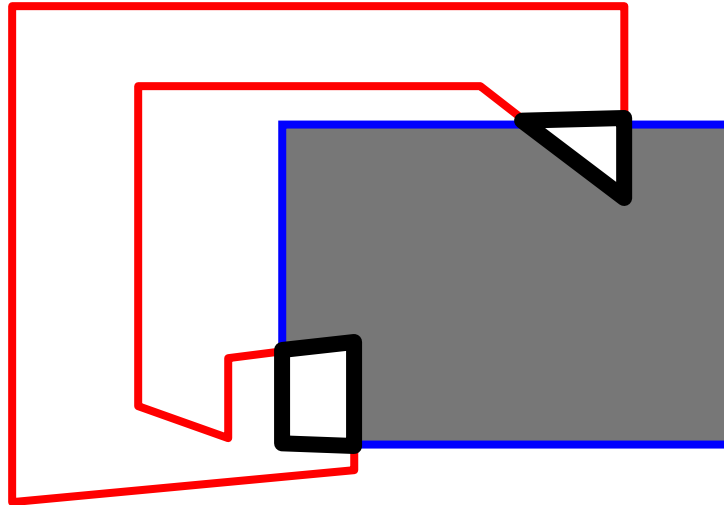

Sutherland-Hodgman Clipping

■ Basic idea:

- consider each edge of the view window individually
- clip the polygon against the view window edge's equation

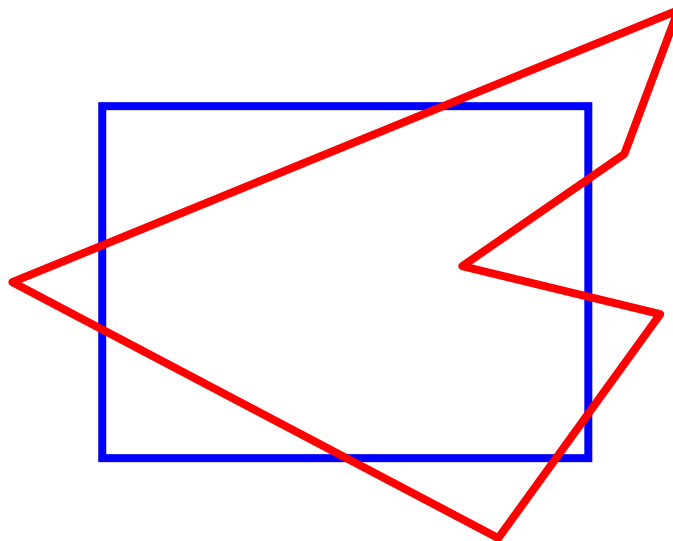

Sutherland-Hodgman Clipping

■ Basic idea:

- consider each edge of the view window individually
- clip the polygon against the view window edge's equation

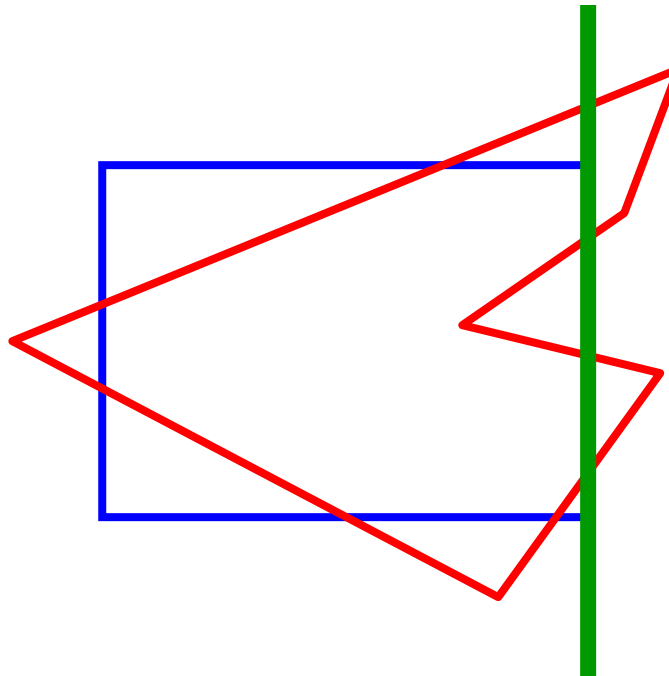

Sutherland-Hodgman Clipping

■ Basic idea:

- consider each edge of the view window individually
- clip the polygon against the view window edge's equation

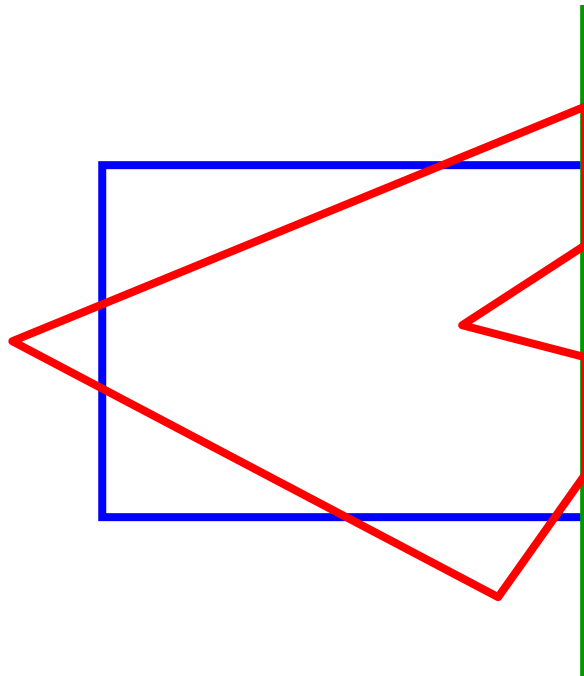

Sutherland-Hodgman Clipping

■ Basic idea:

- consider each edge of the view window individually
- clip the polygon against the view window edge's equation

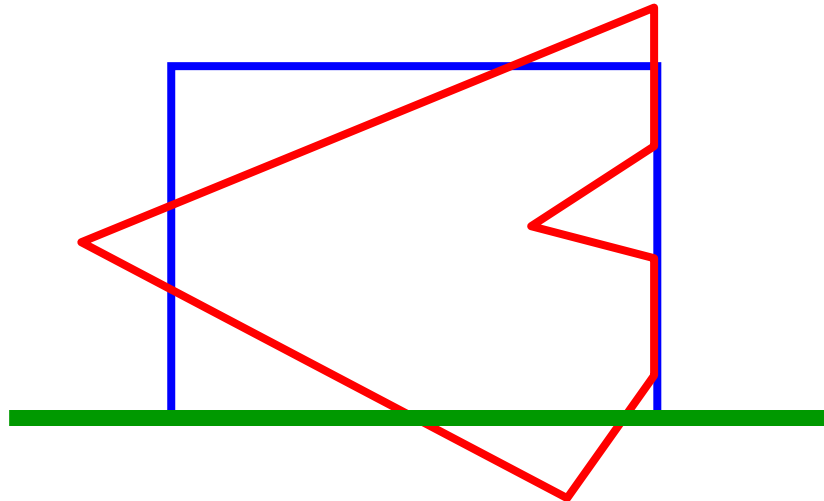

Sutherland-Hodgman Clipping

■ Basic idea:

- consider each edge of the view window individually
- clip the polygon against the view window edge's equation

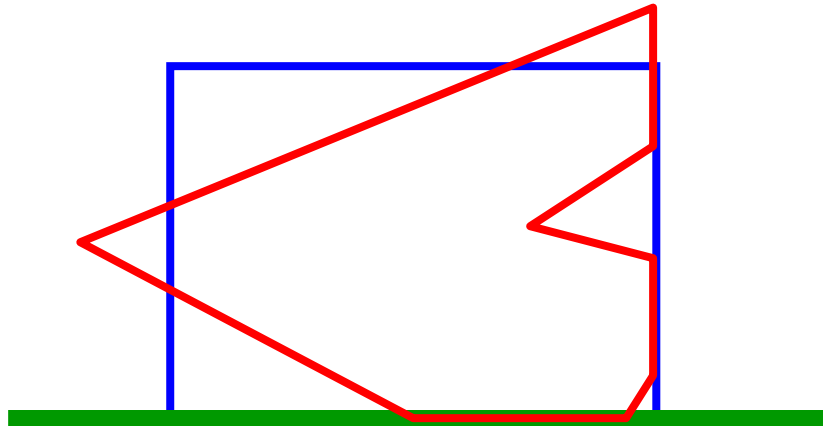

Sutherland-Hodgman Clipping

■ Basic idea:

- consider each edge of the view window individually
- clip the polygon against the view window edge's equation

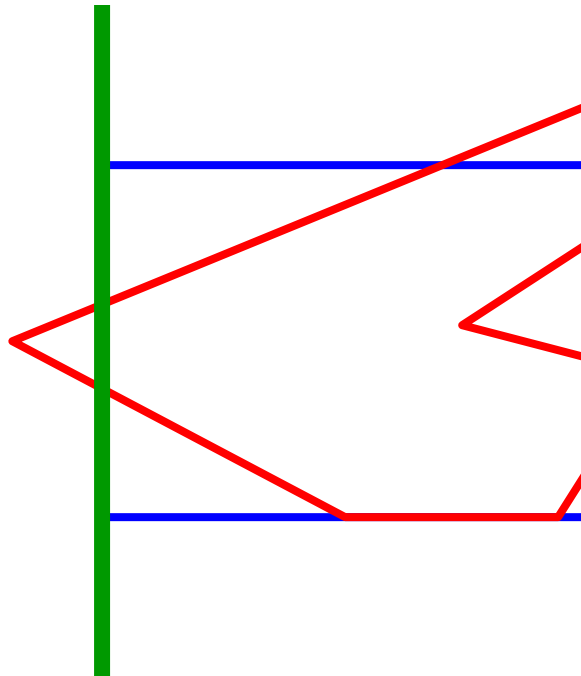

Sutherland-Hodgman Clipping

■ Basic idea:

- consider each edge of the view window individually
- clip the polygon against the view window edge's equation

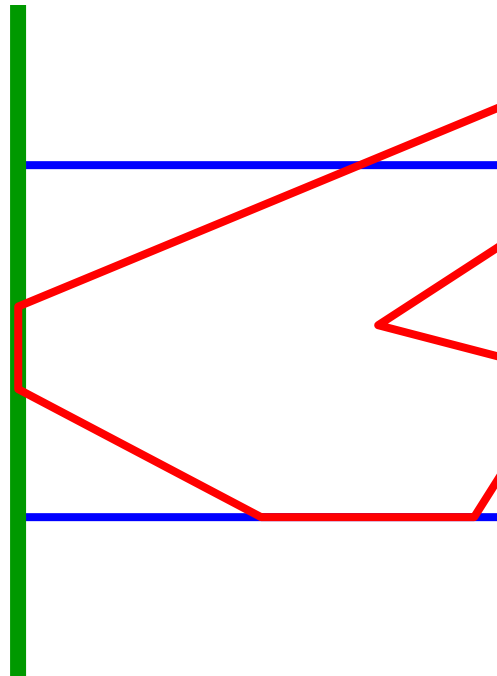

Sutherland-Hodgman Clipping

■ Basic idea:

- consider each edge of the view window individually
- clip the polygon against the view window edge's equation

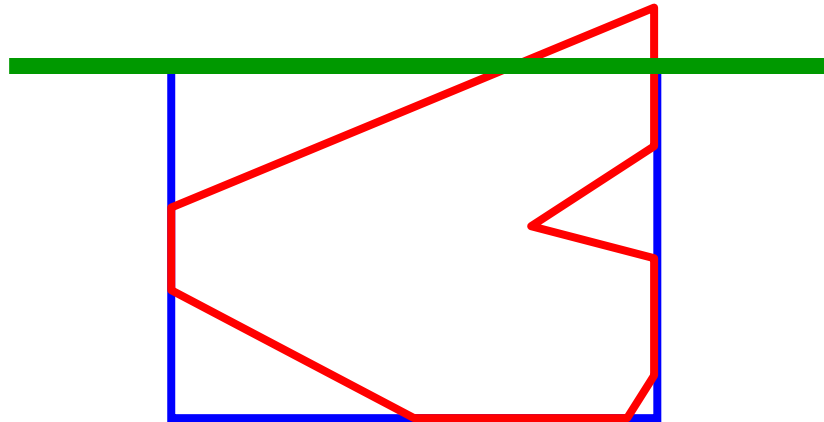

Sutherland-Hodgman Clipping

■ Basic idea:

- consider each edge of the view window individually
- clip the polygon against the view window edge's equation

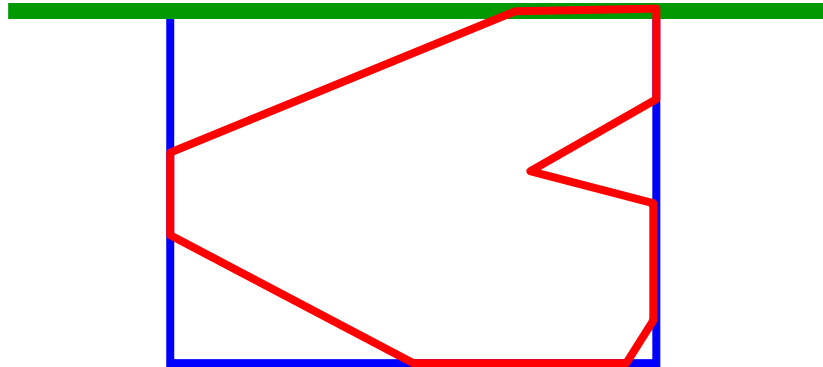

Sutherland-Hodgman Clipping

■ Basic idea:

- consider each edge of the view window individually
- clip the polygon against the view window edge's equation
- **after doing all edges, the polygon is fully clipped**

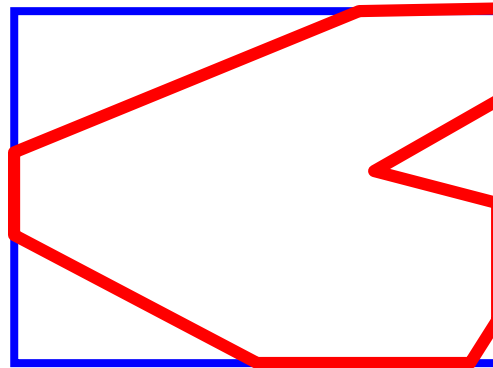

Sutherland-Hodgman Clipping

- Input/output for algorithm:
 - input: list of polygon vertices in order
{abcdef}

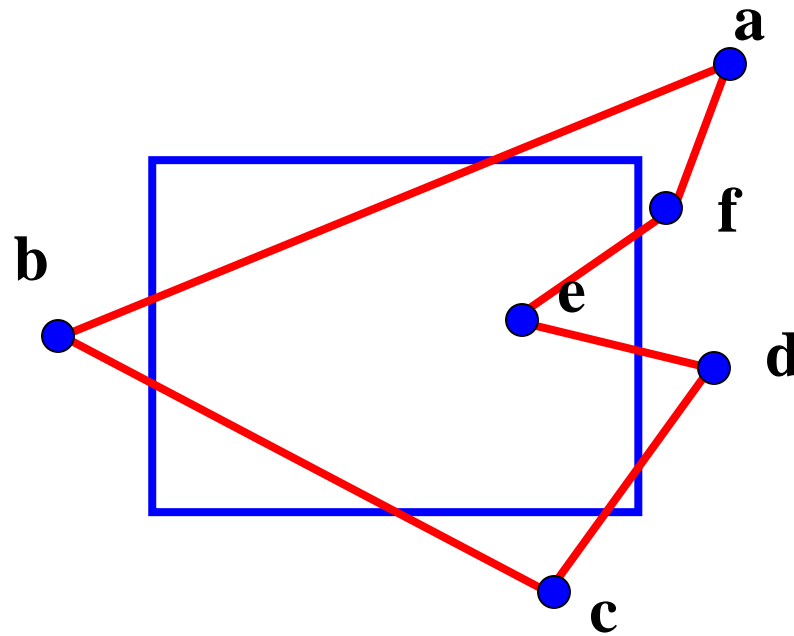

Sutherland-Hodgman Clipping

■ Input/output for algorithm:

- input: list of polygon vertices in order
- output: list of clipped polygon vertices consisting of old vertices (maybe) and new vertices (maybe)

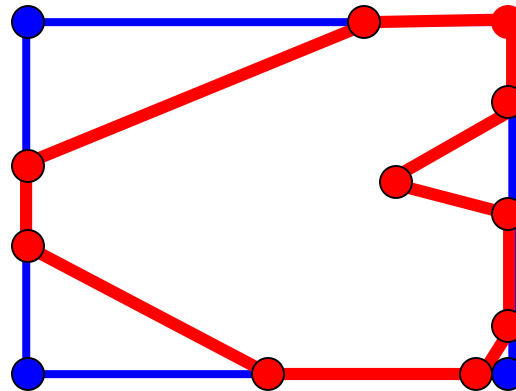

Sutherland-Hodgman Clipping

- Edge from S to E takes one of four cases:

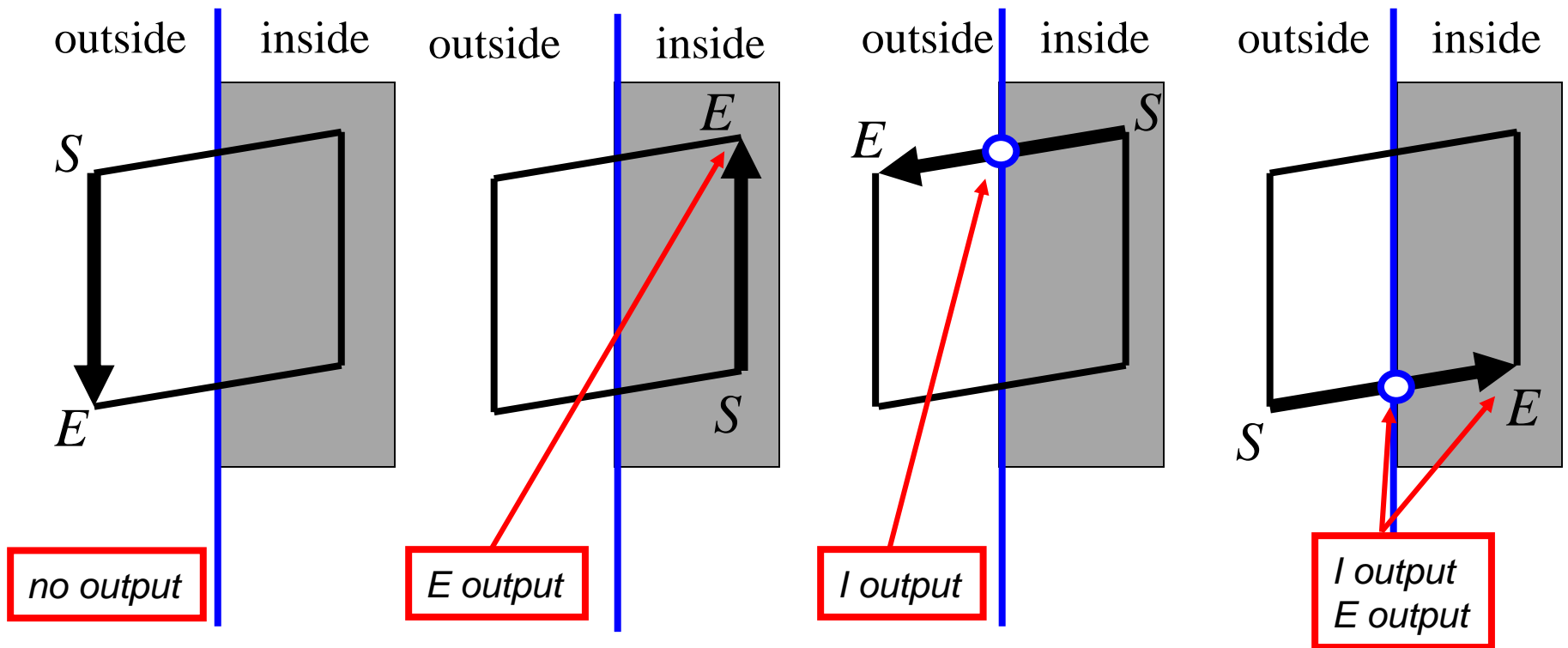

Sutherland-Hodgman Algorithm

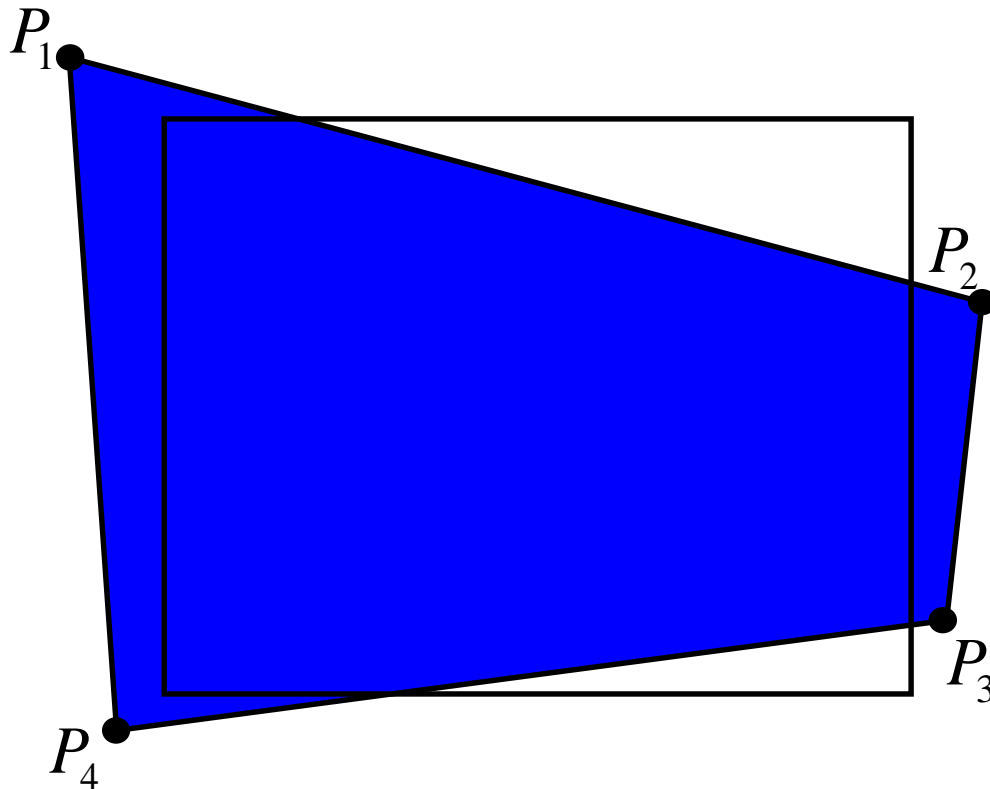
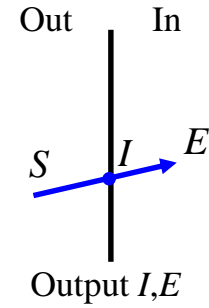
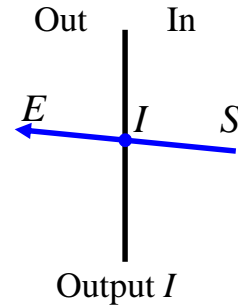
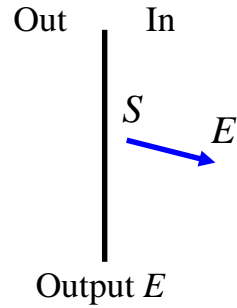
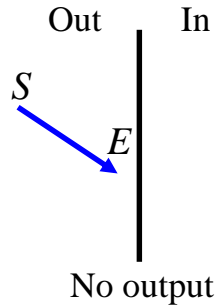

Sutherland-Hodgman Algorithm

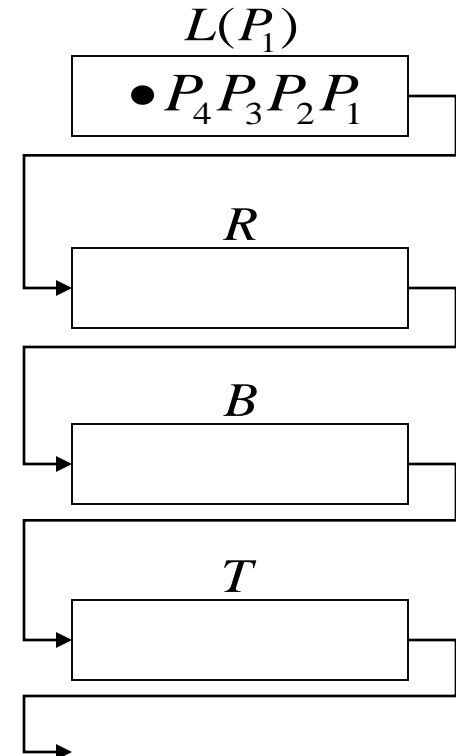
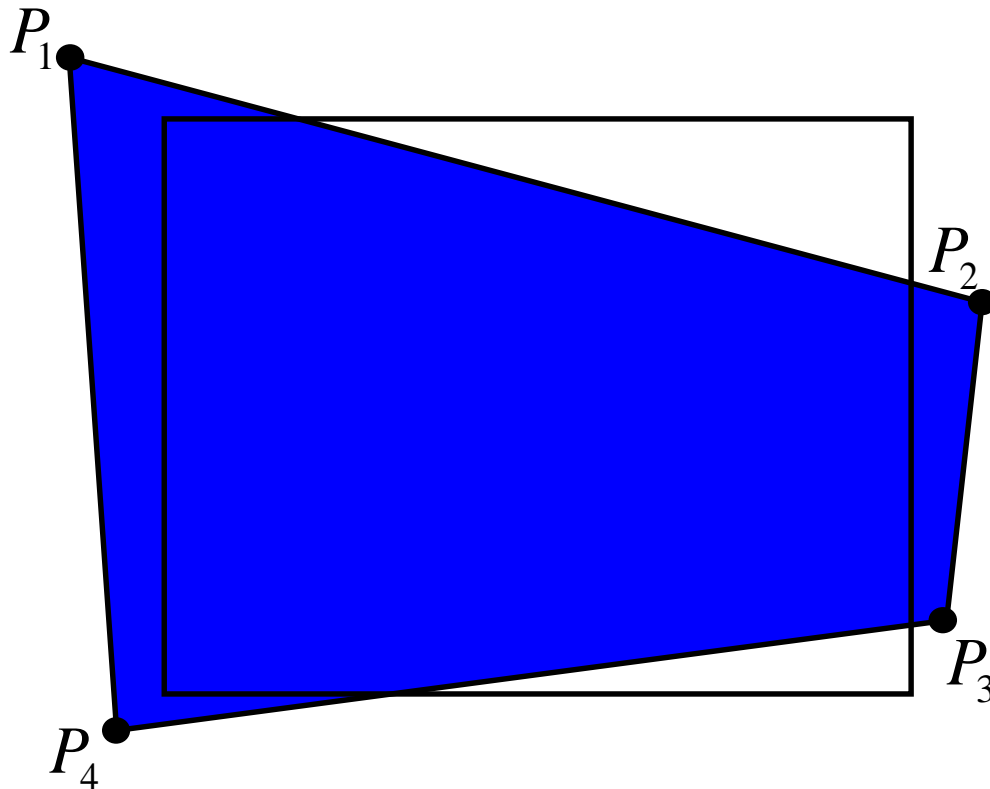
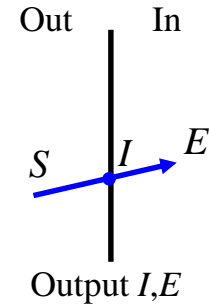
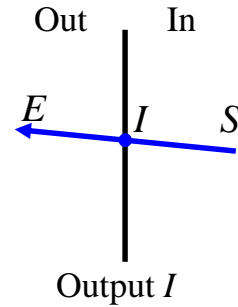
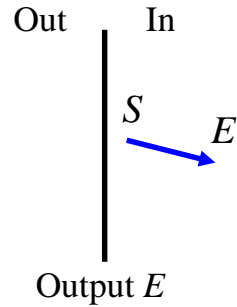
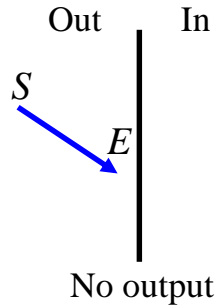

Sutherland-Hodgman Algorithm

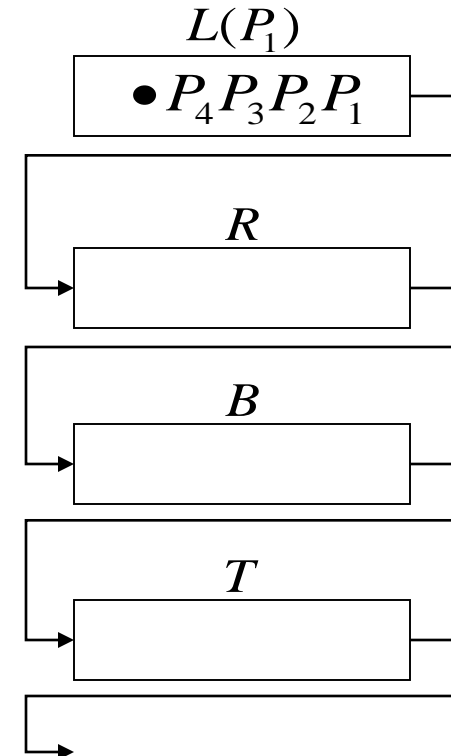
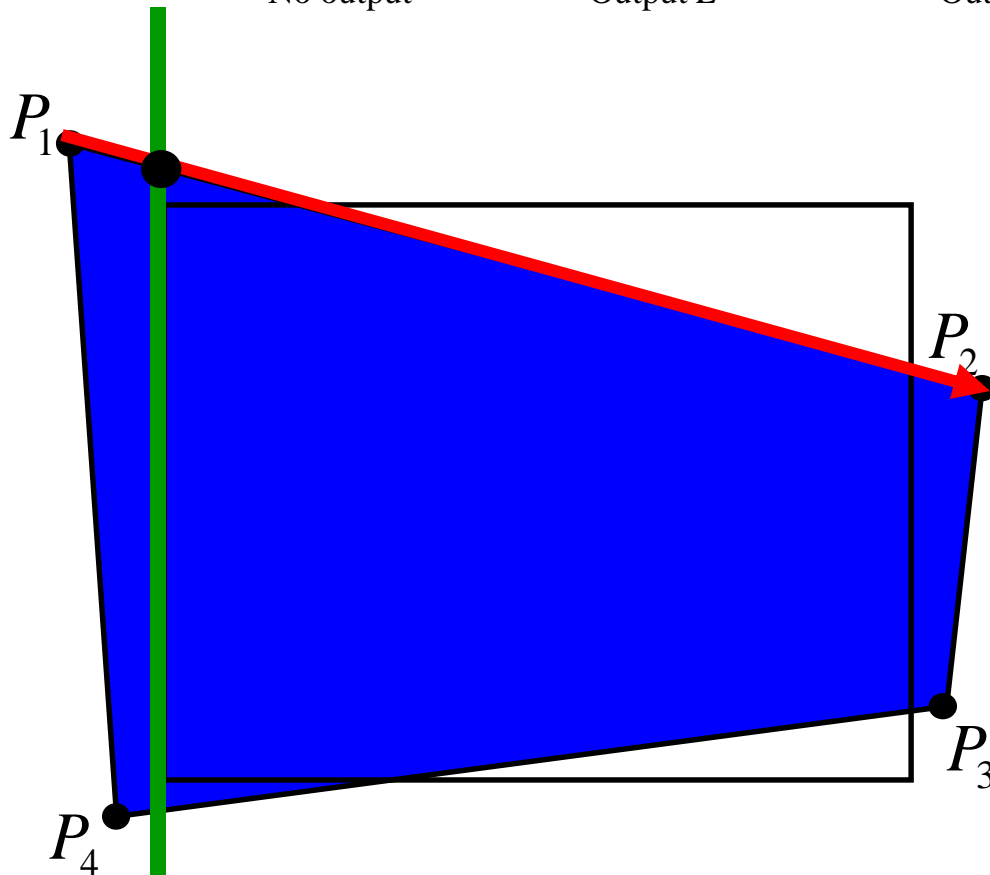
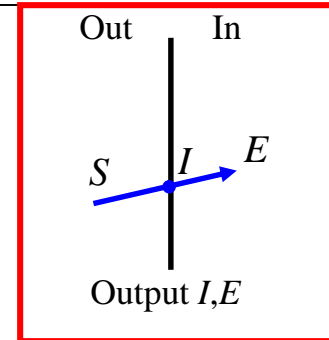
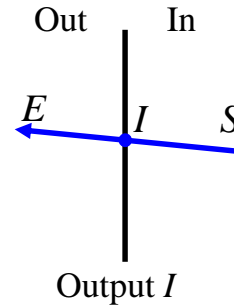
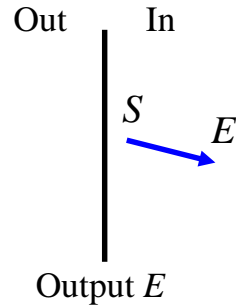
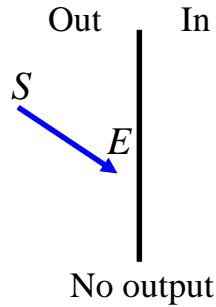

Sutherland-Hodgman Algorithm

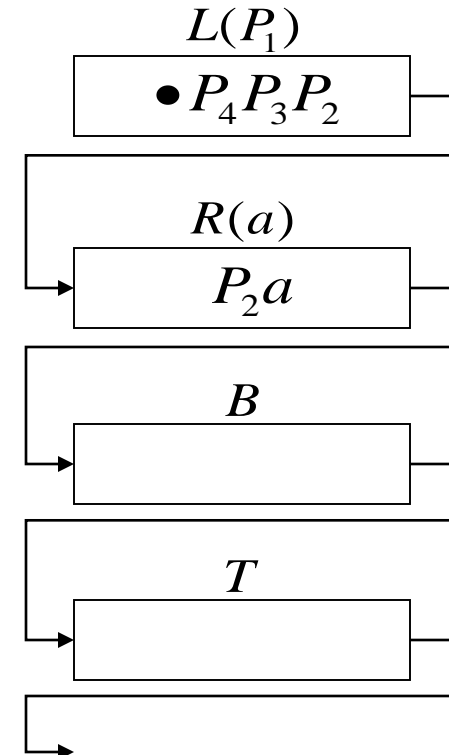
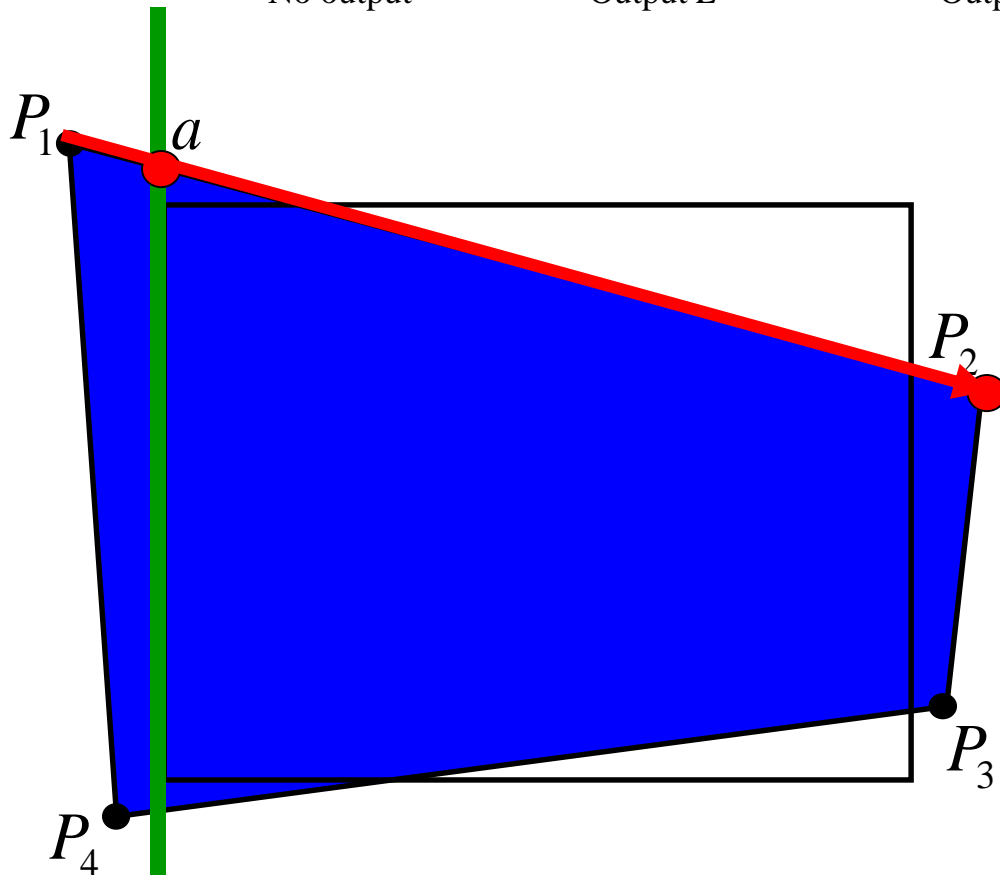
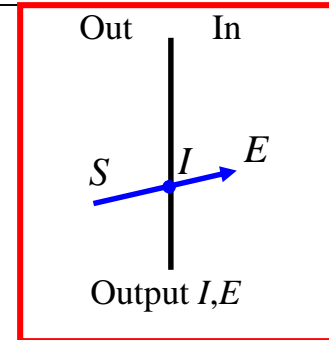
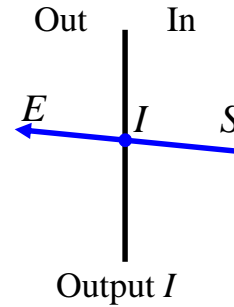
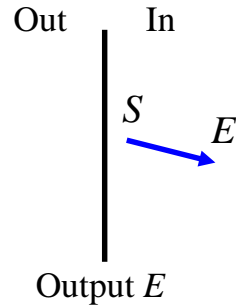
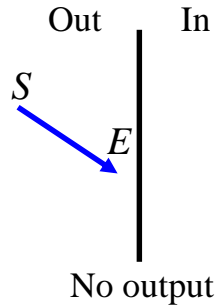

Sutherland-Hodgman Algorithm

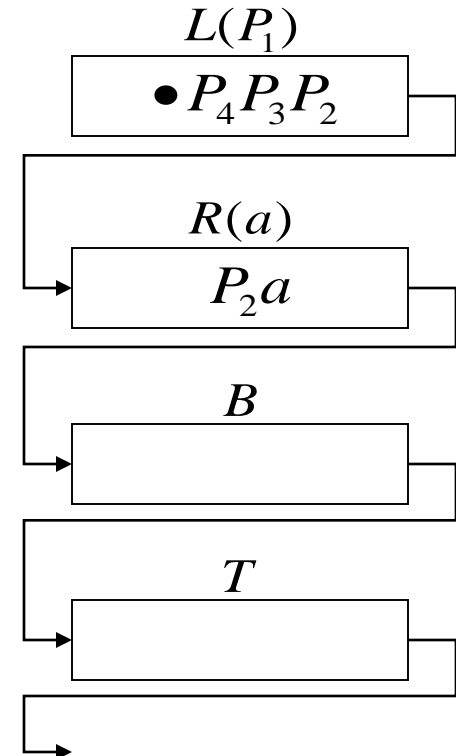
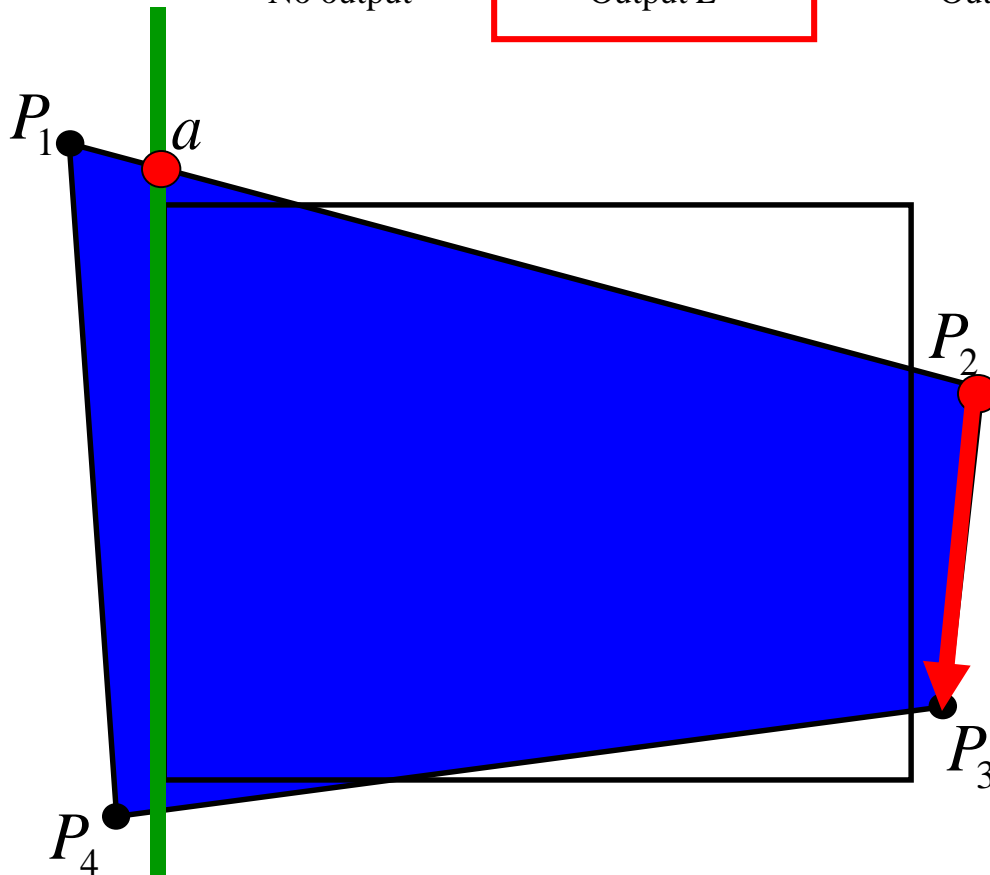
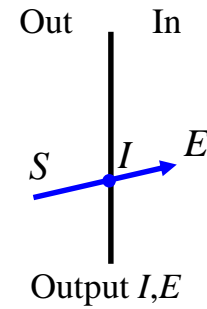
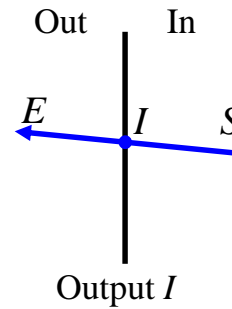
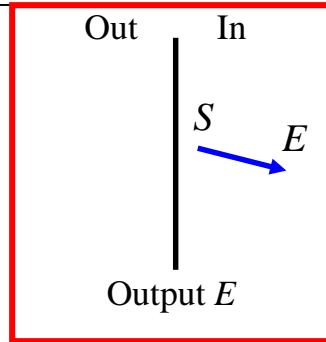
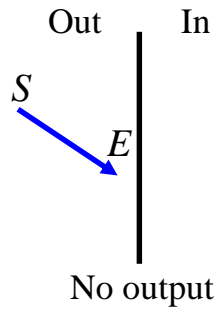

Sutherland-Hodgman Algorithm

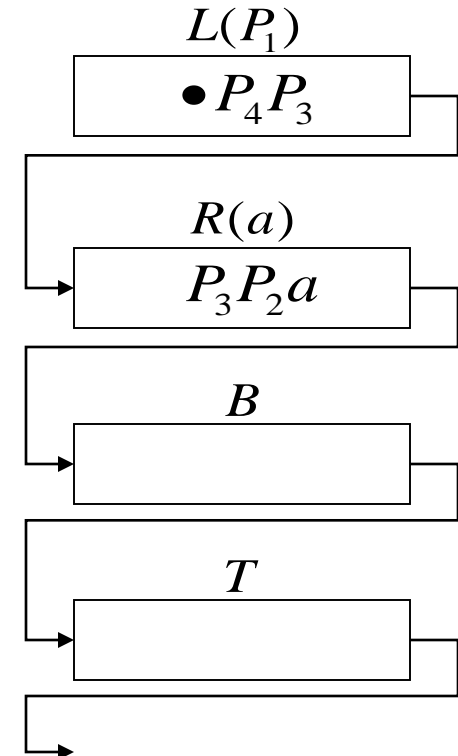
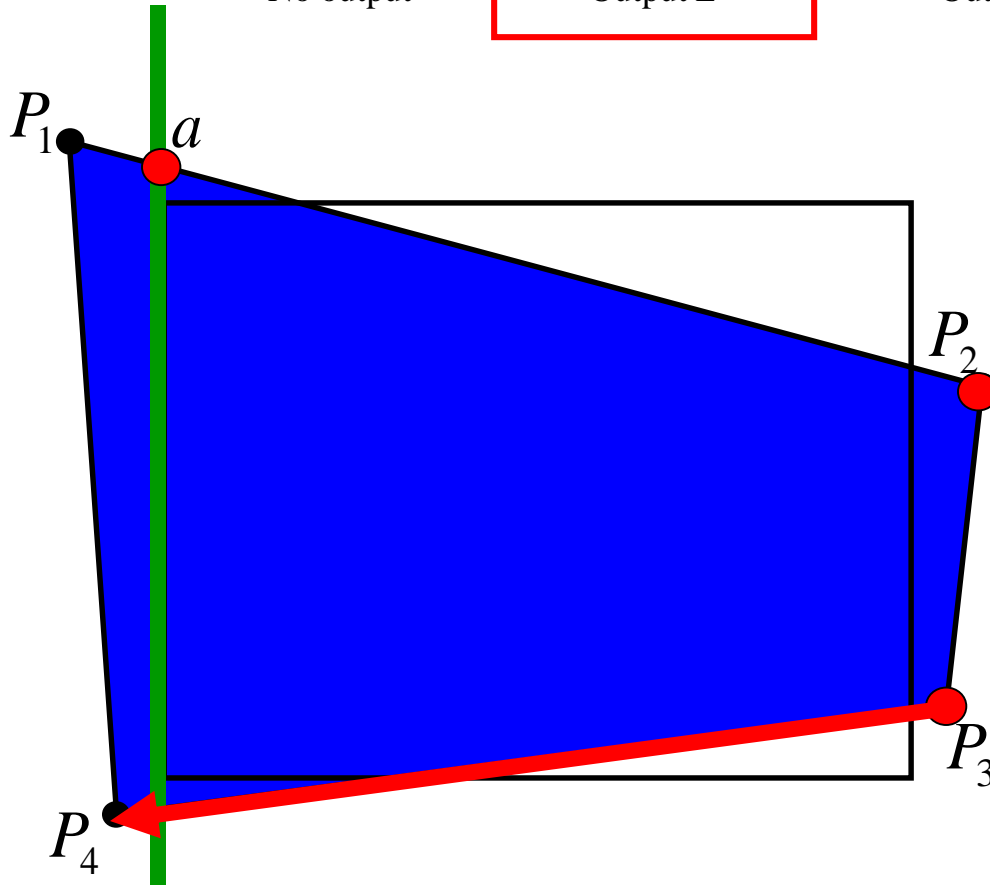
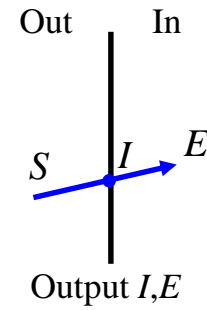
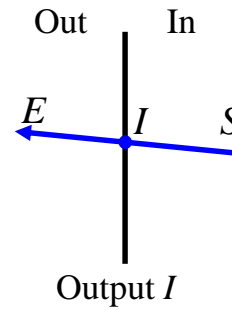
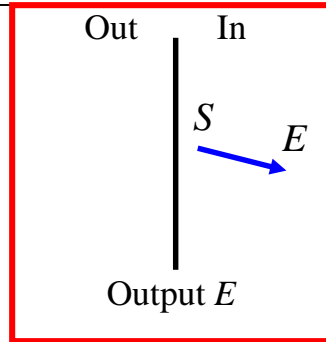
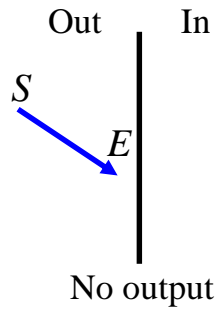

Sutherland-Hodgman Algorithm

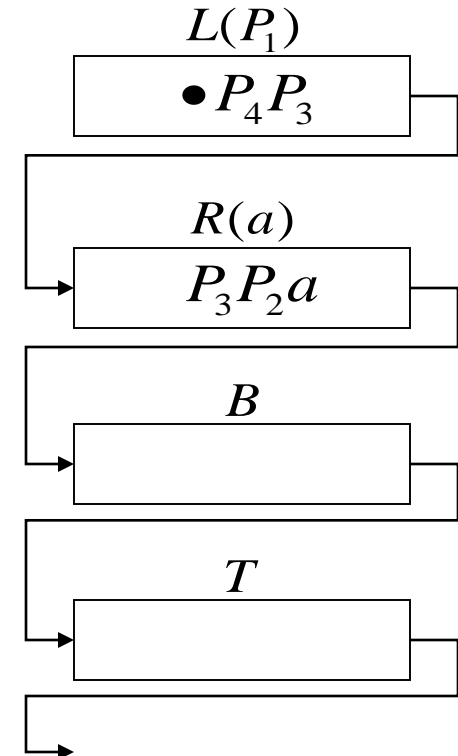
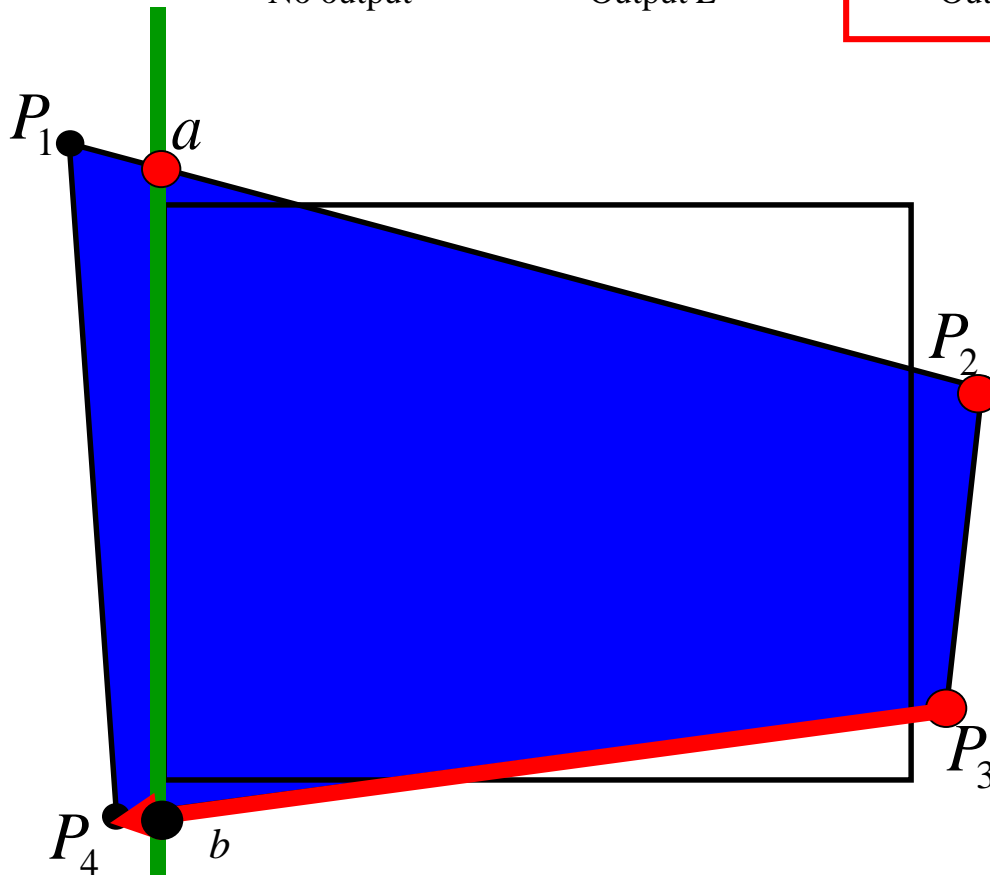
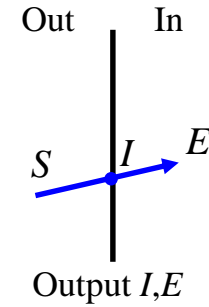
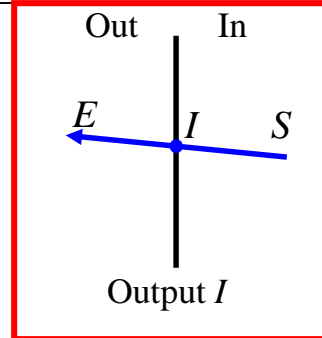
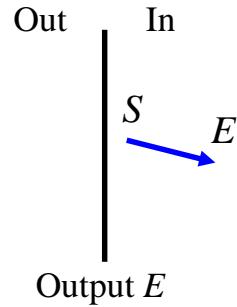
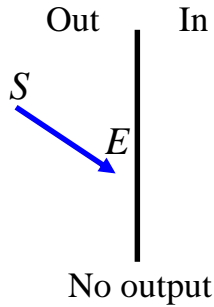

Sutherland-Hodgman Algorithm

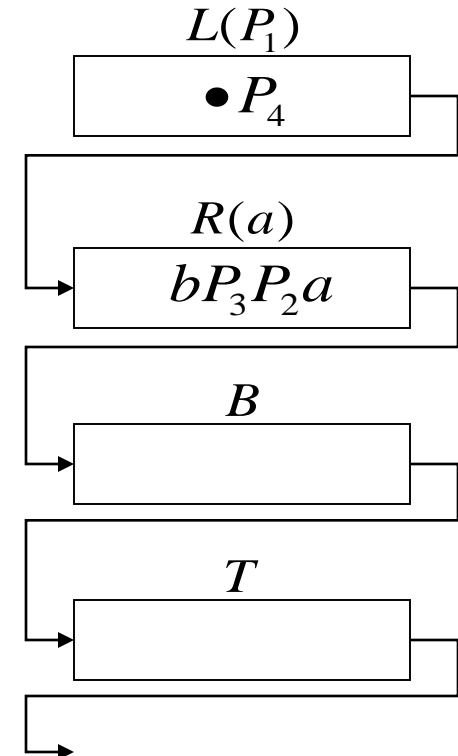
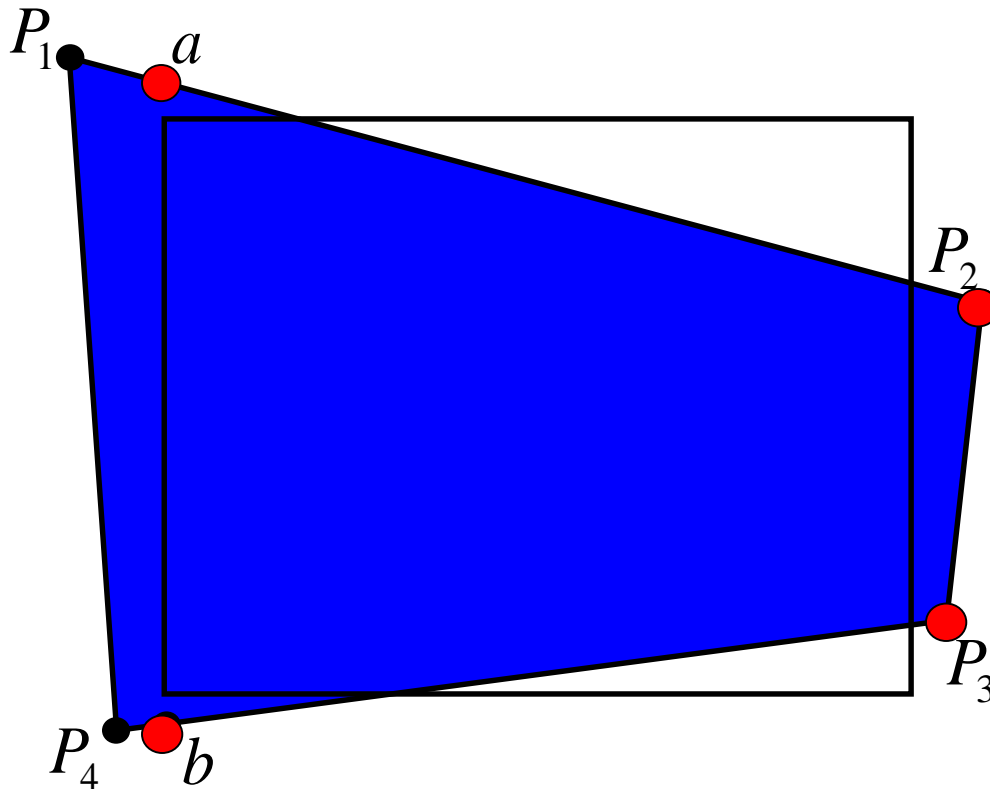
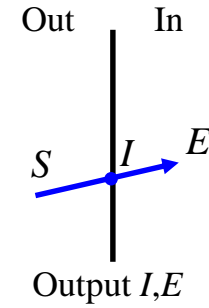
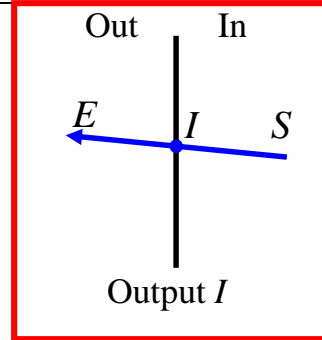
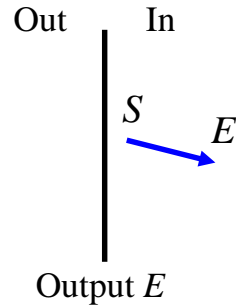
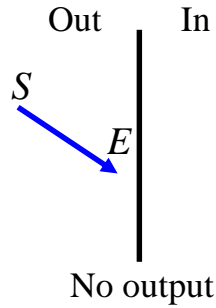

Sutherland-Hodgman Algorithm

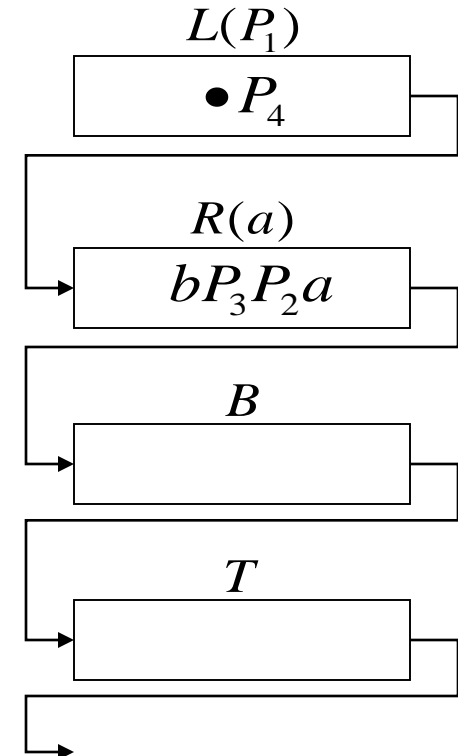
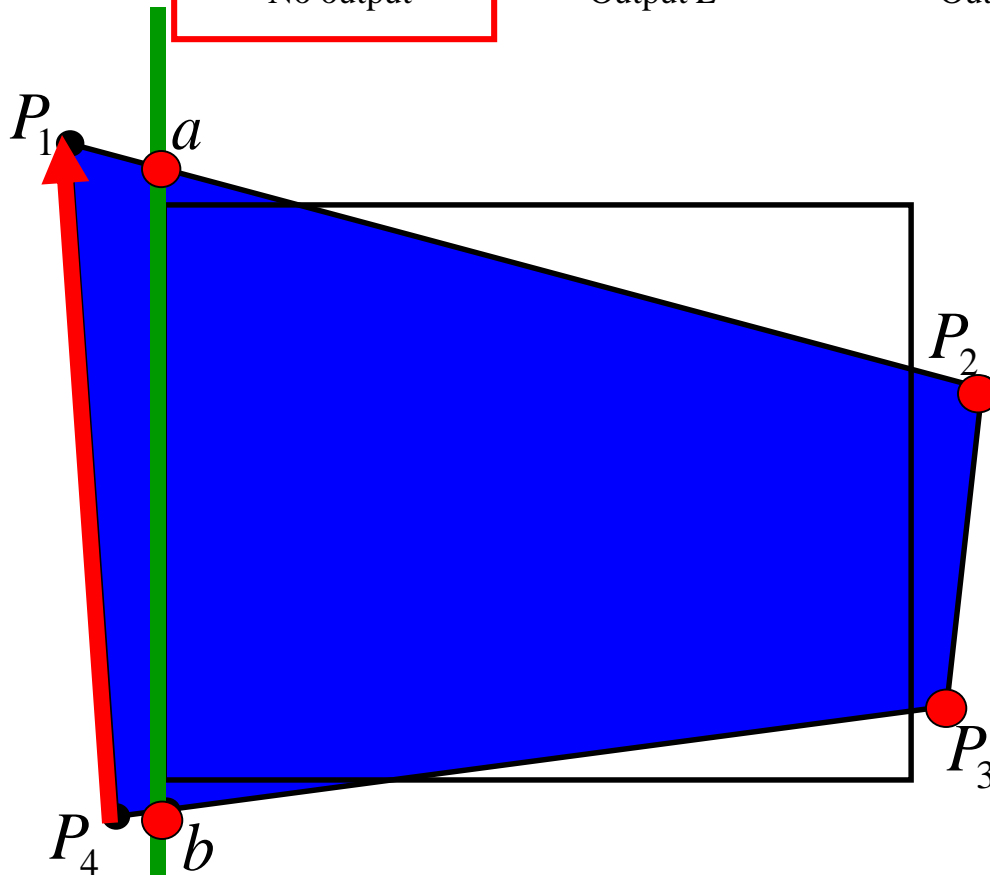
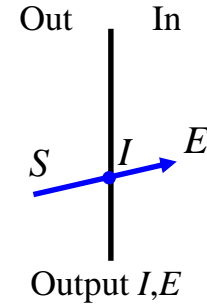
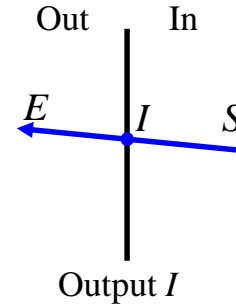
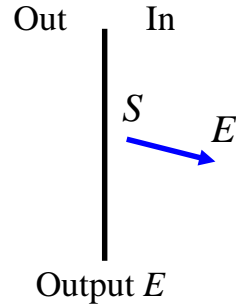
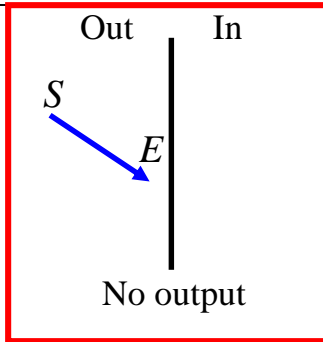

Sutherland-Hodgman Algorithm

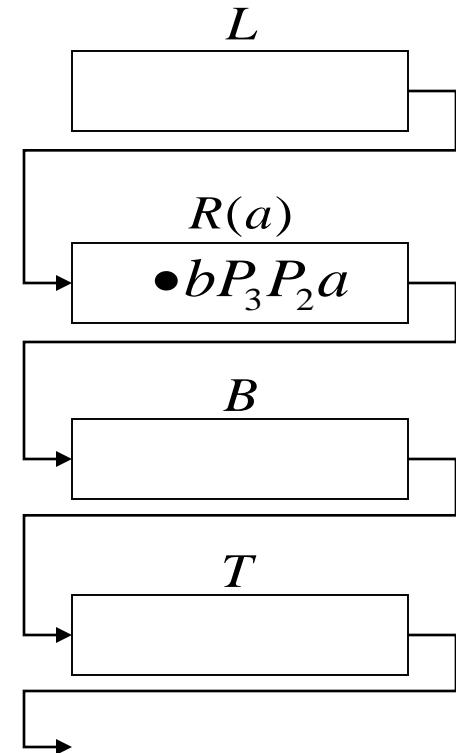
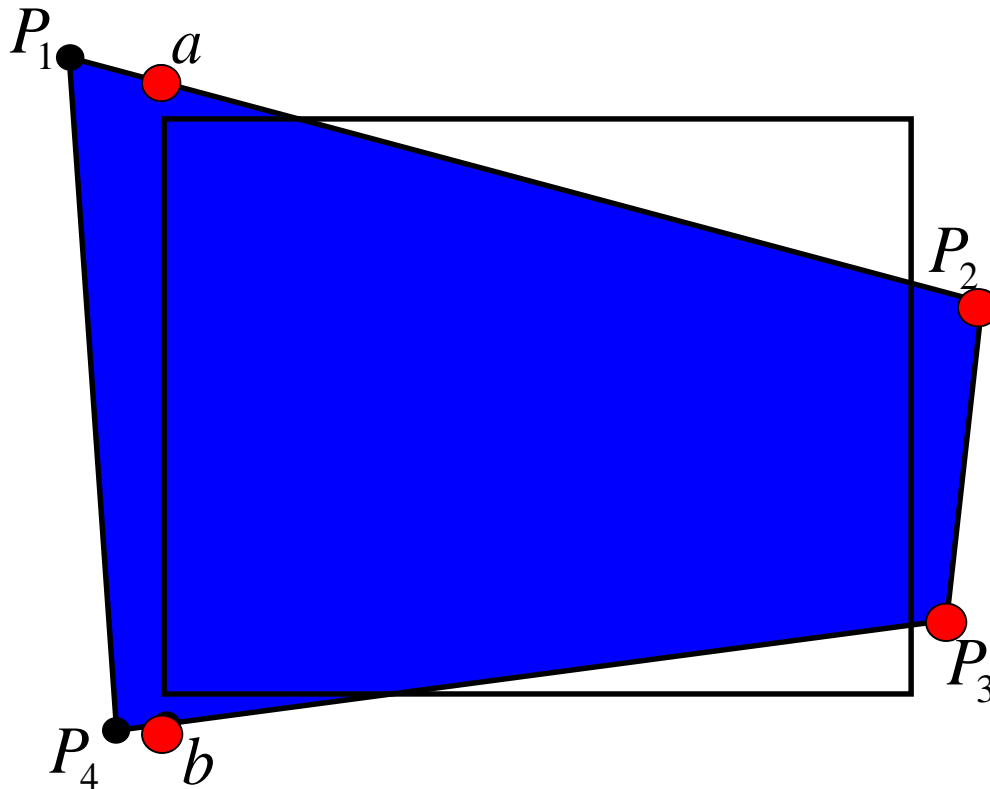
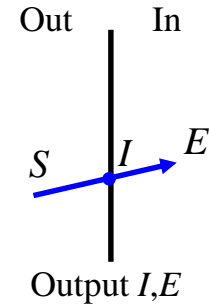
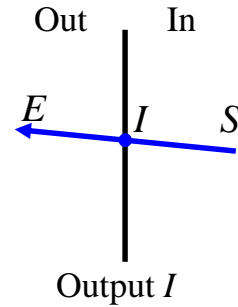
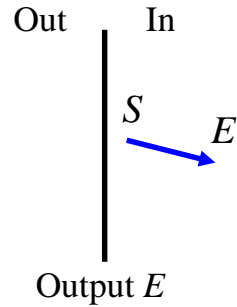
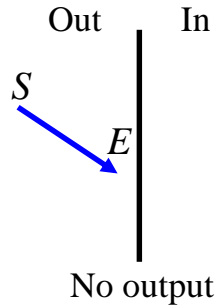

Sutherland-Hodgman Algorithm

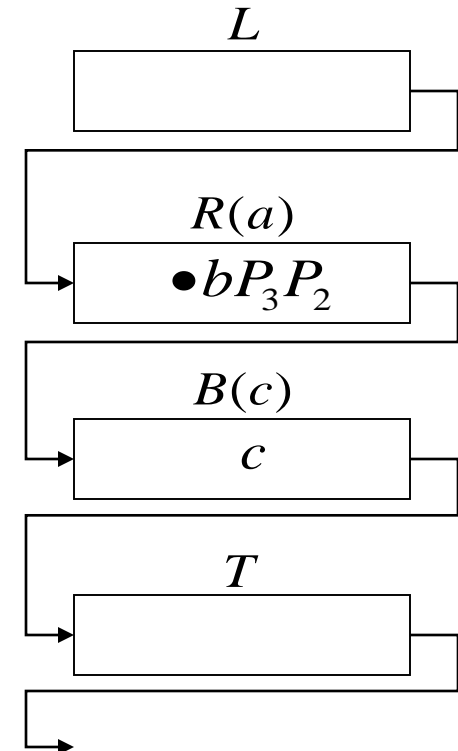
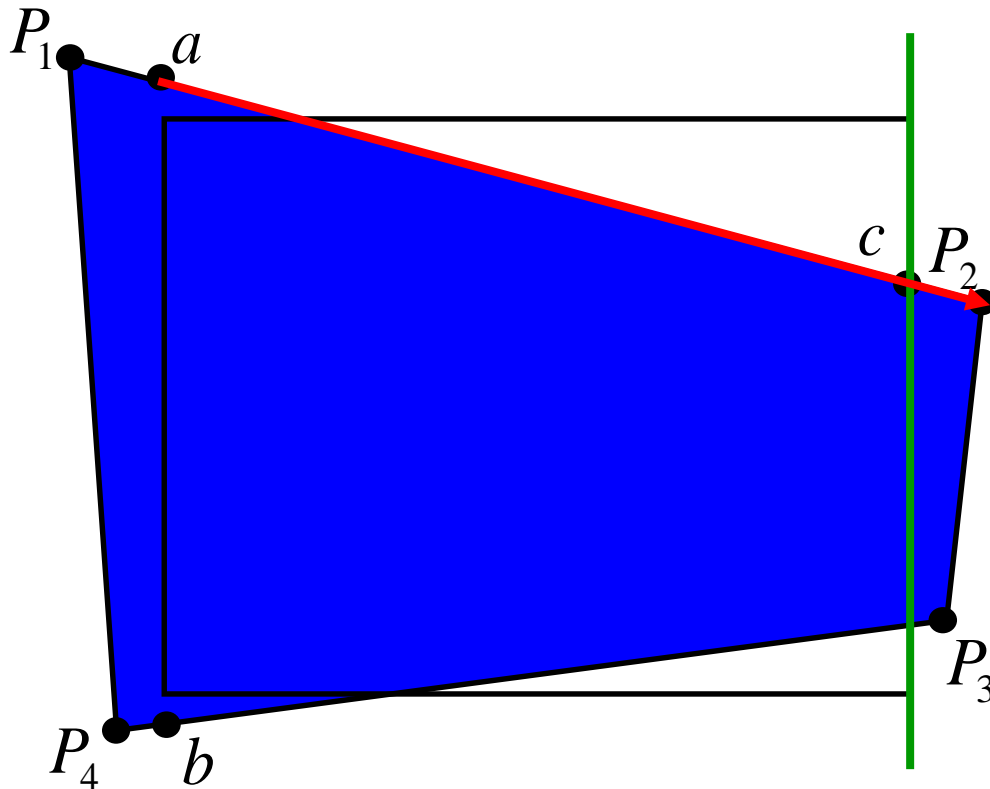
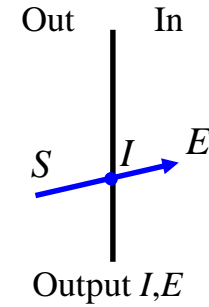
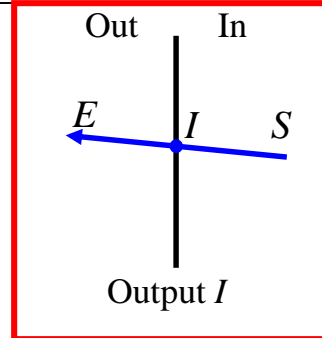
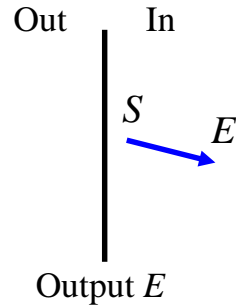
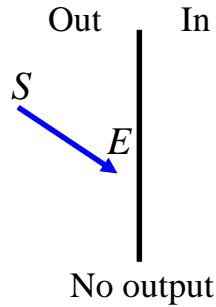

Sutherland-Hodgman Algorithm

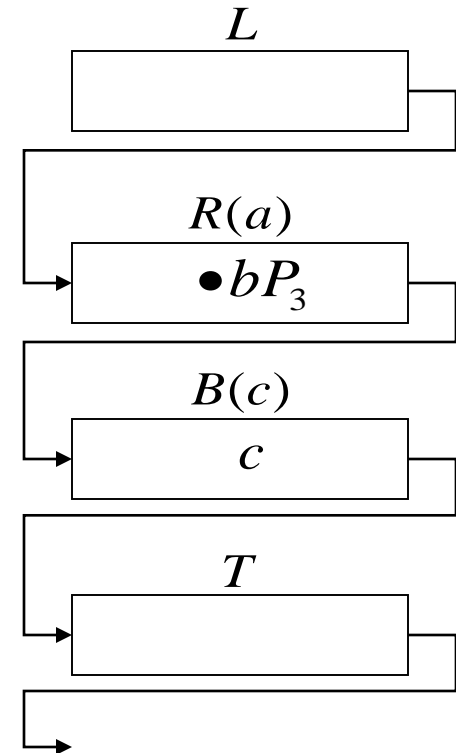
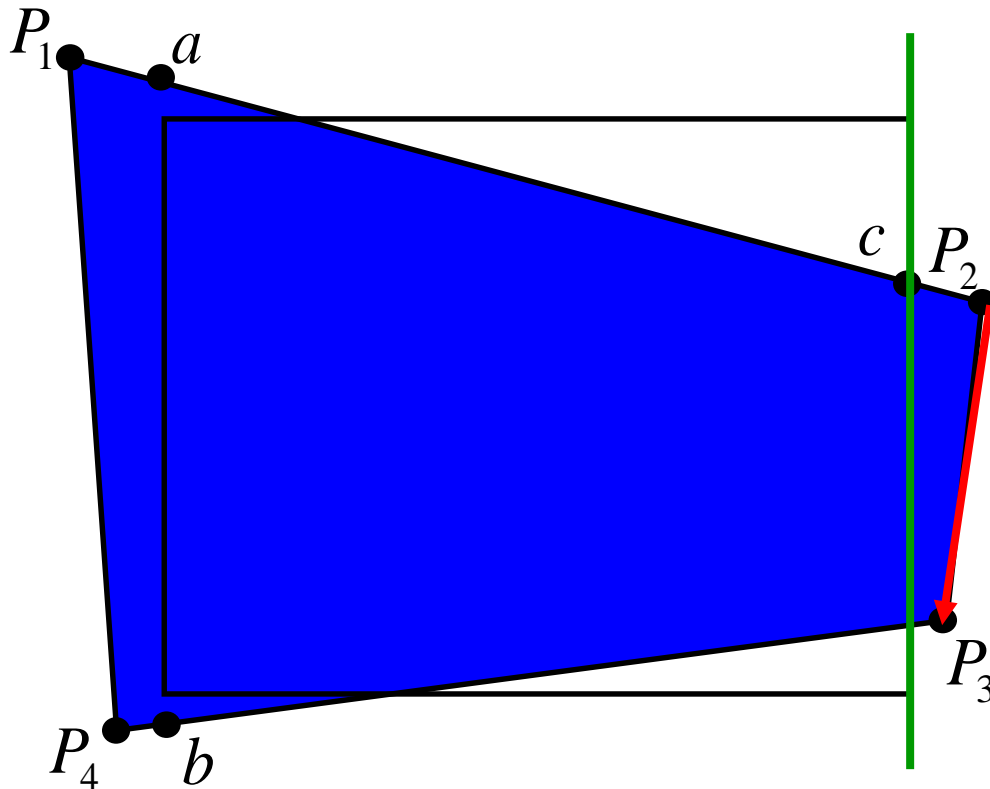
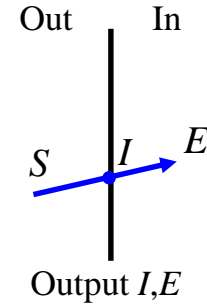
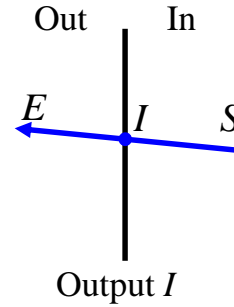
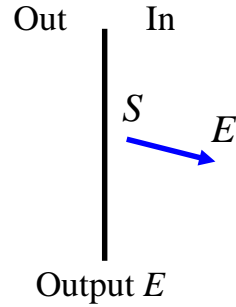
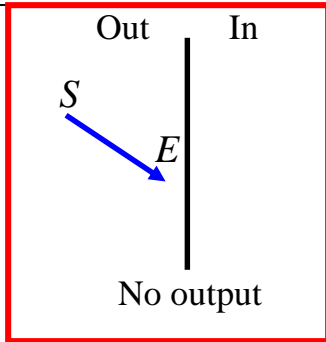

Sutherland-Hodgman Algorithm

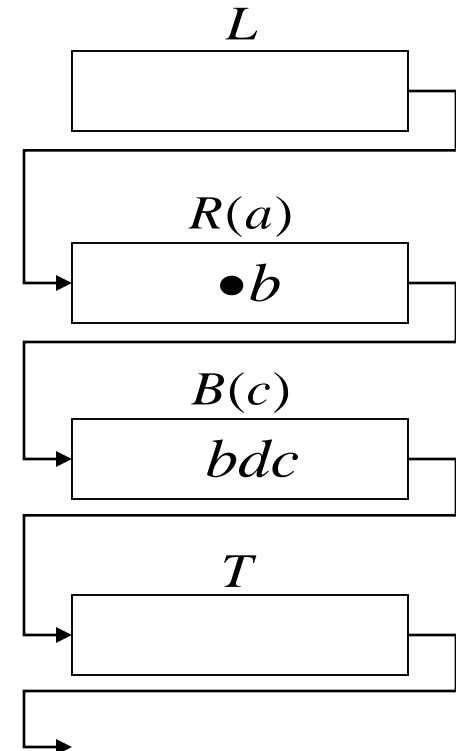
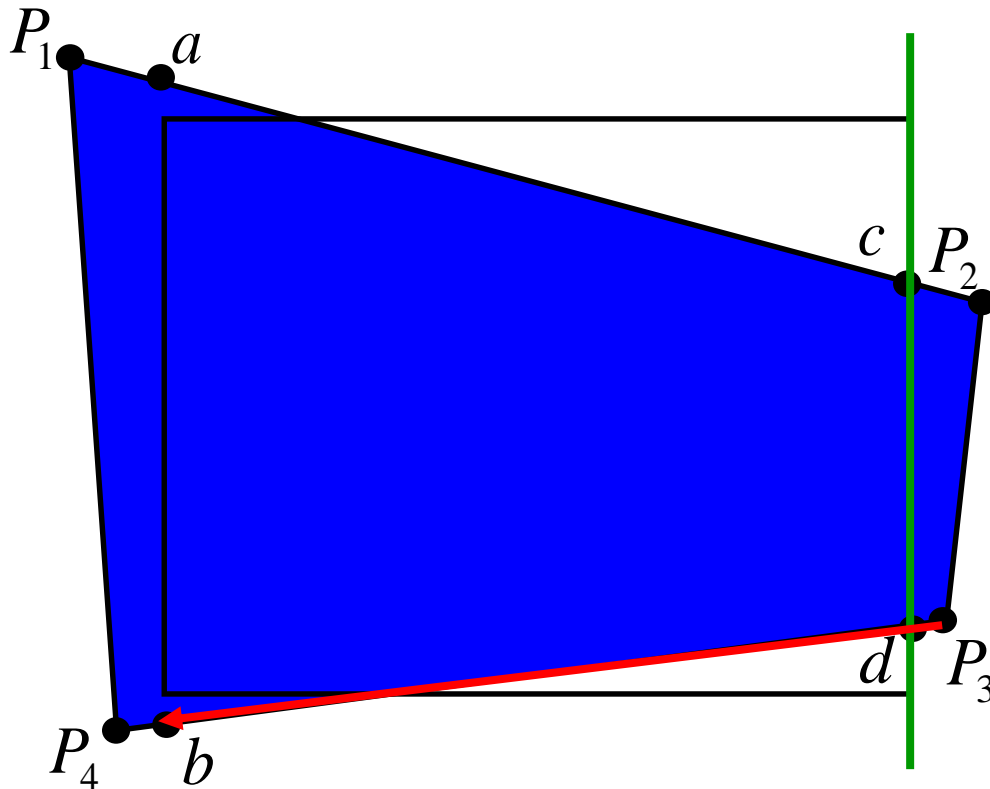
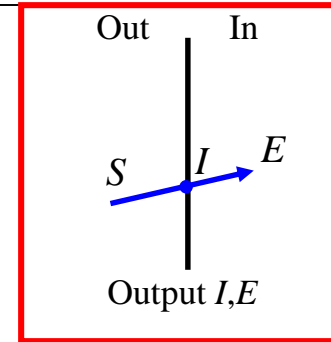
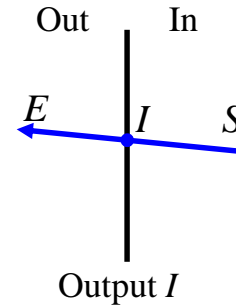
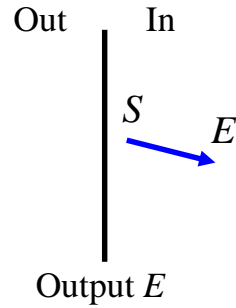
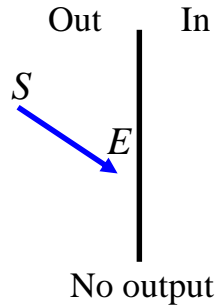

Sutherland-Hodgman Algorithm

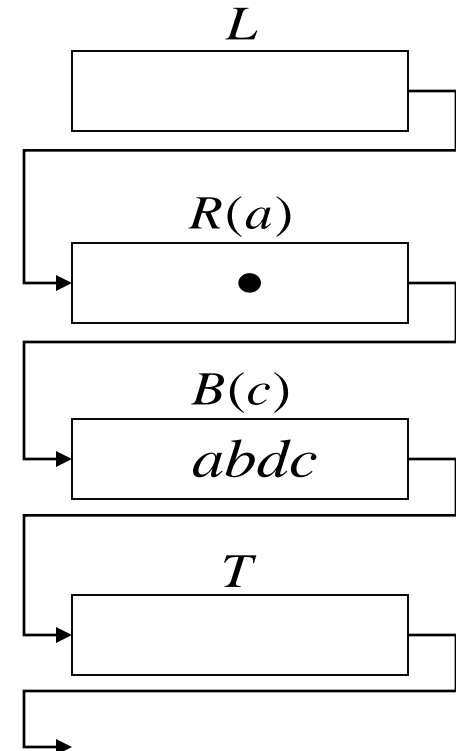
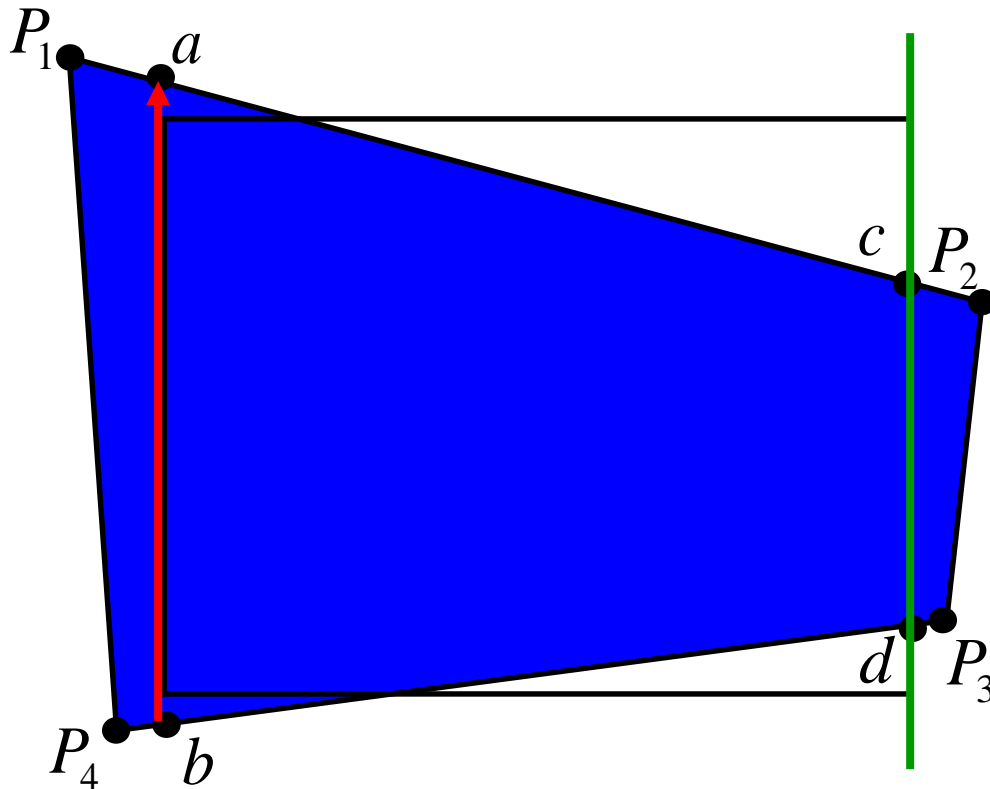
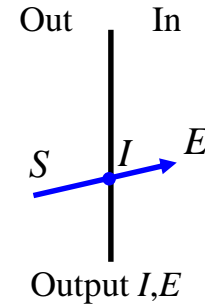
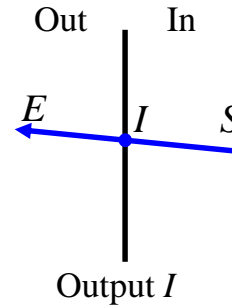
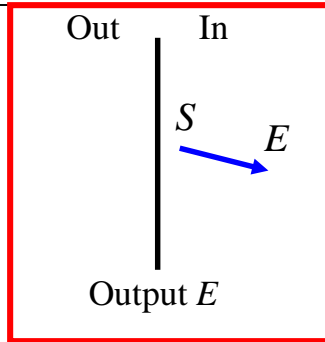
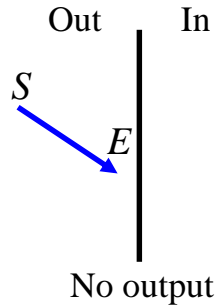

Sutherland-Hodgman Algorithm

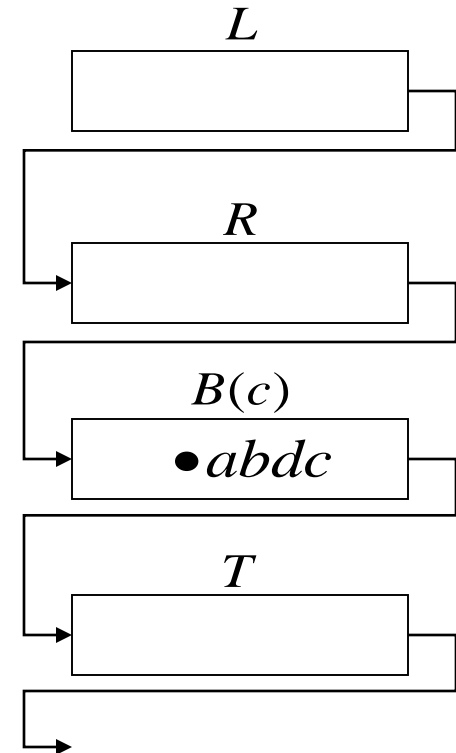
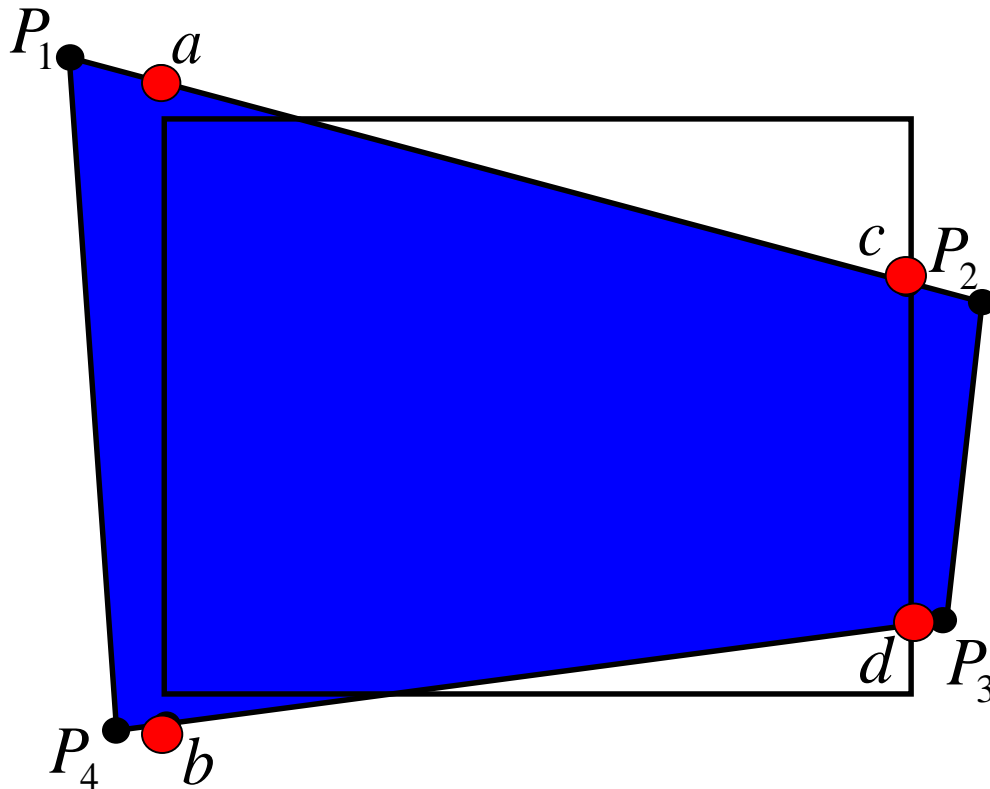
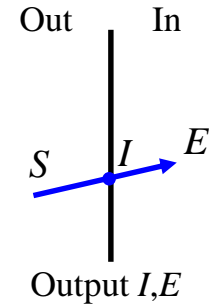
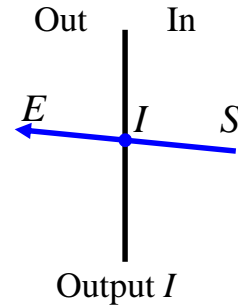
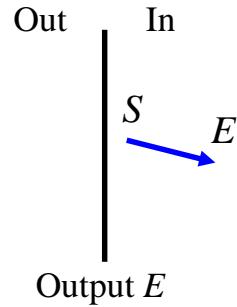
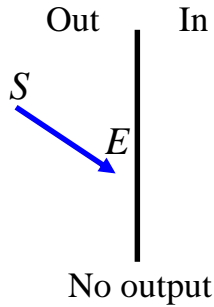

Sutherland-Hodgman Algorithm

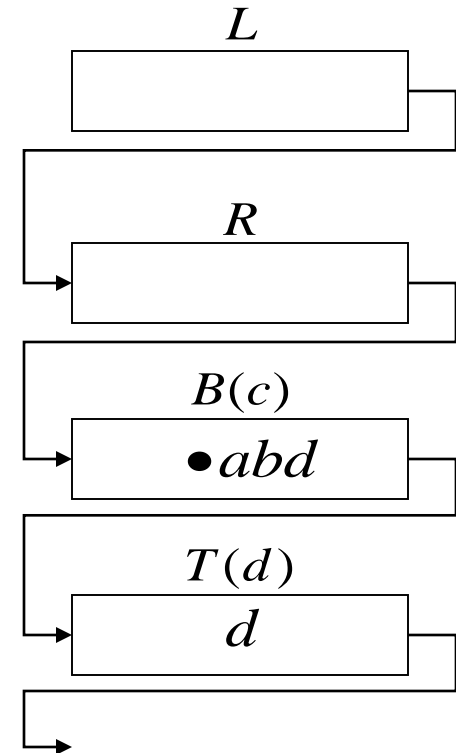
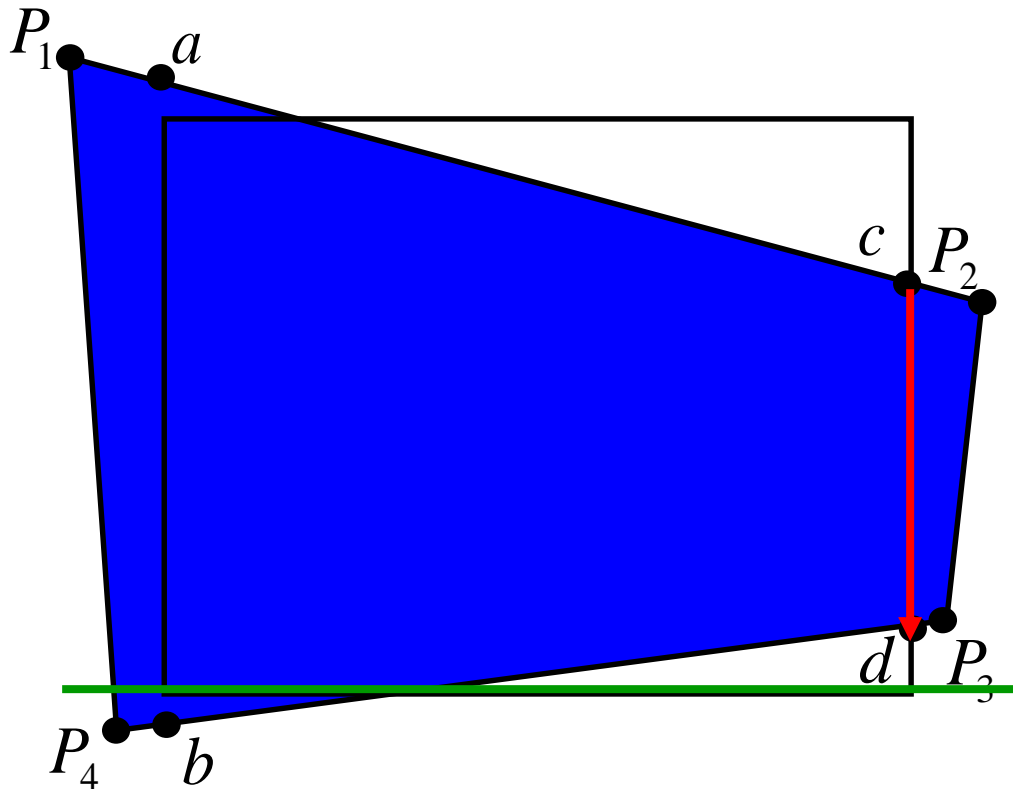
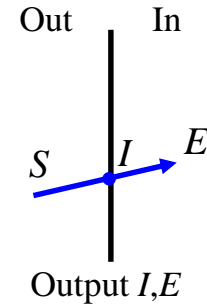
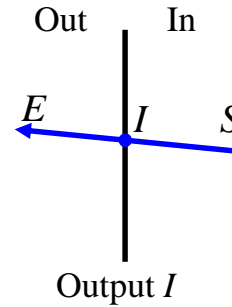
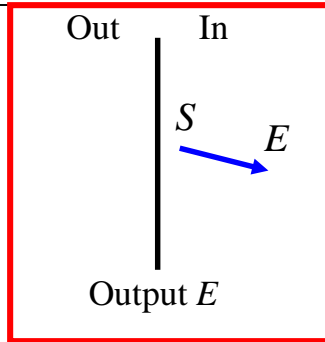
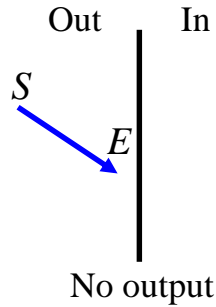

Sutherland-Hodgman Algorithm

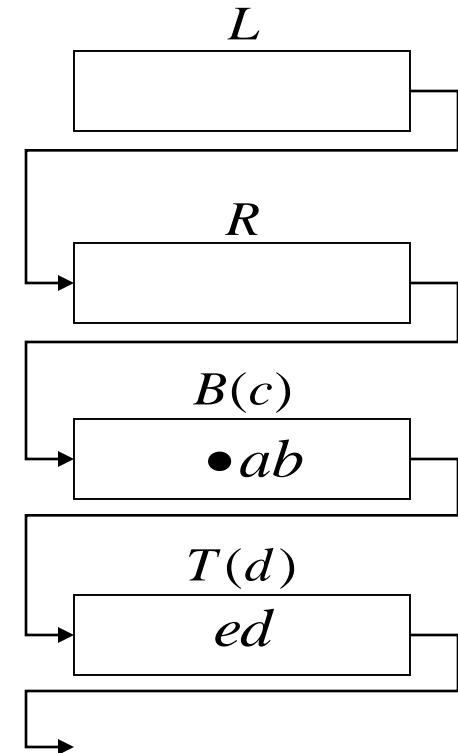
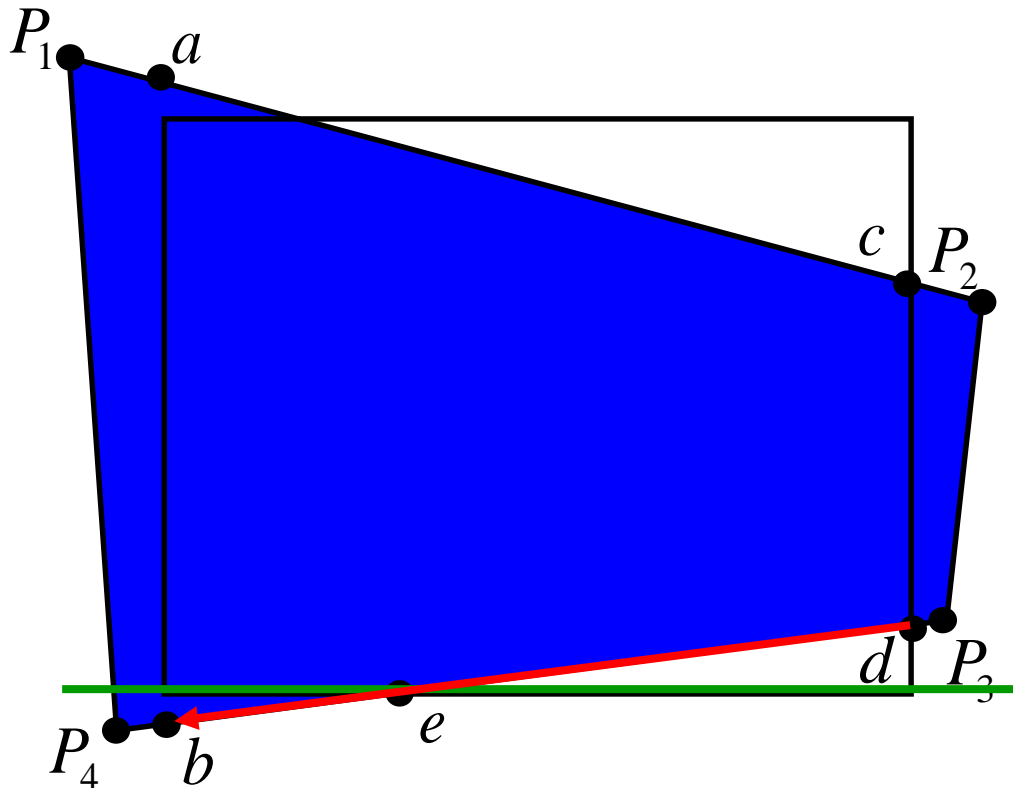
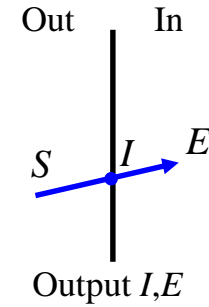
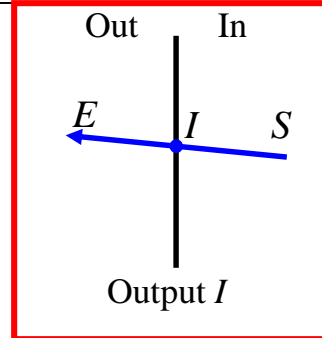
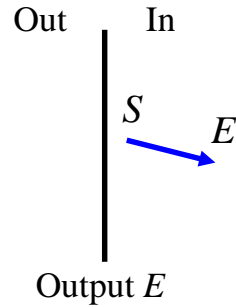
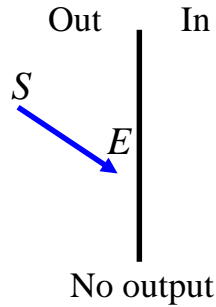

Sutherland-Hodgman Algorithm

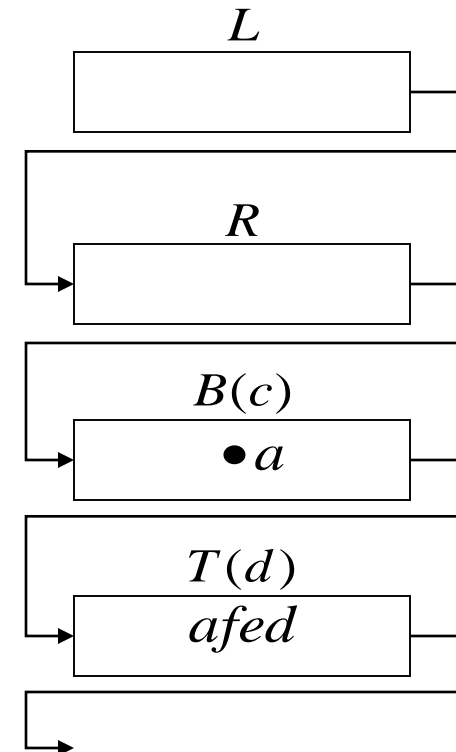
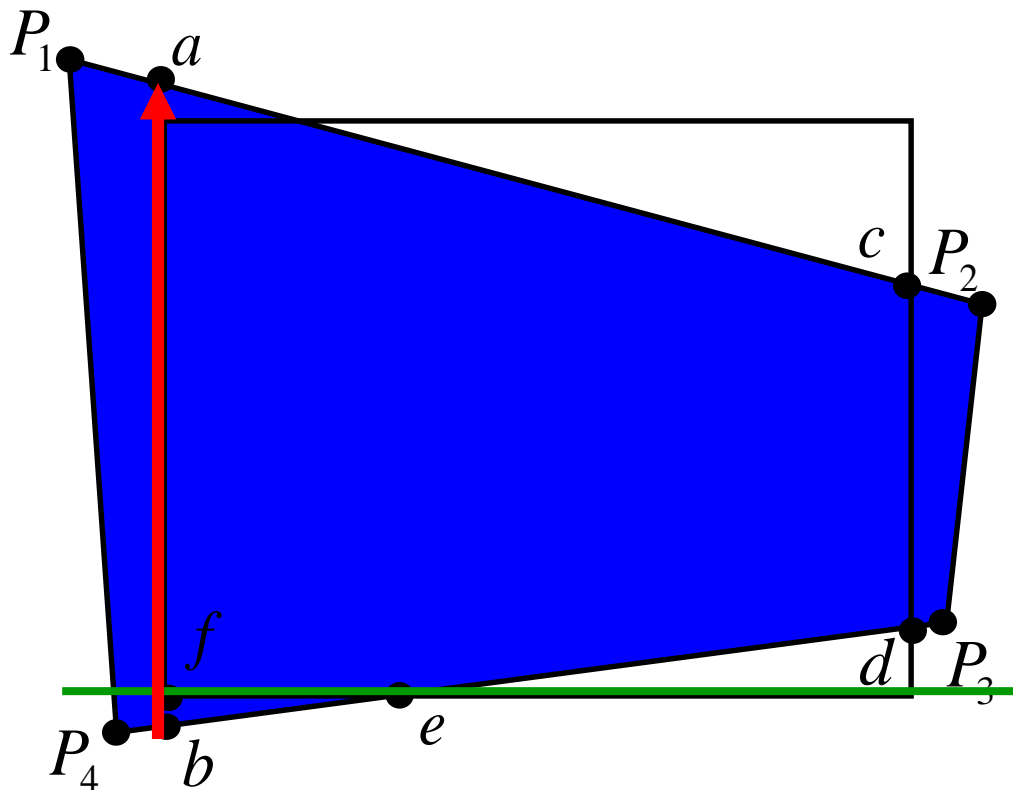
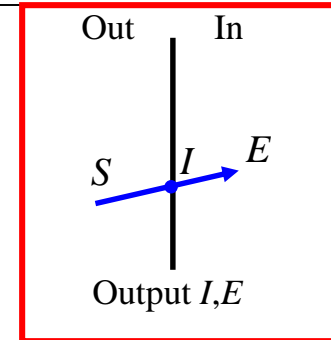
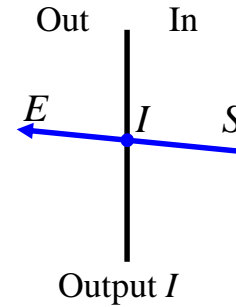
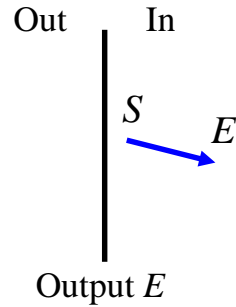
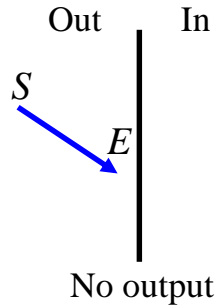

Sutherland-Hodgman Algorithm

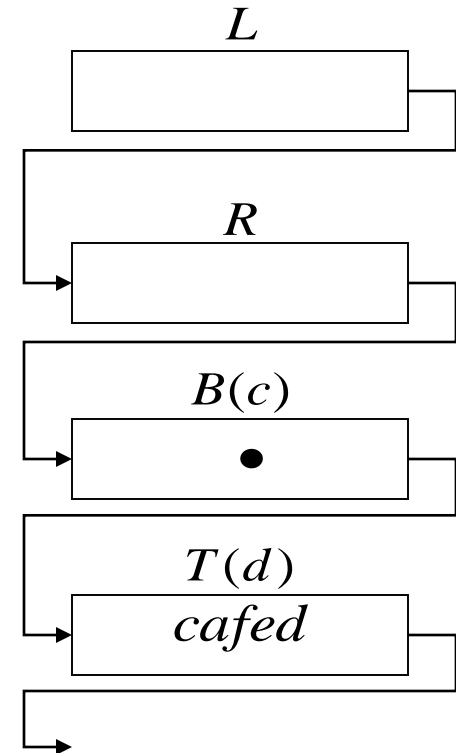
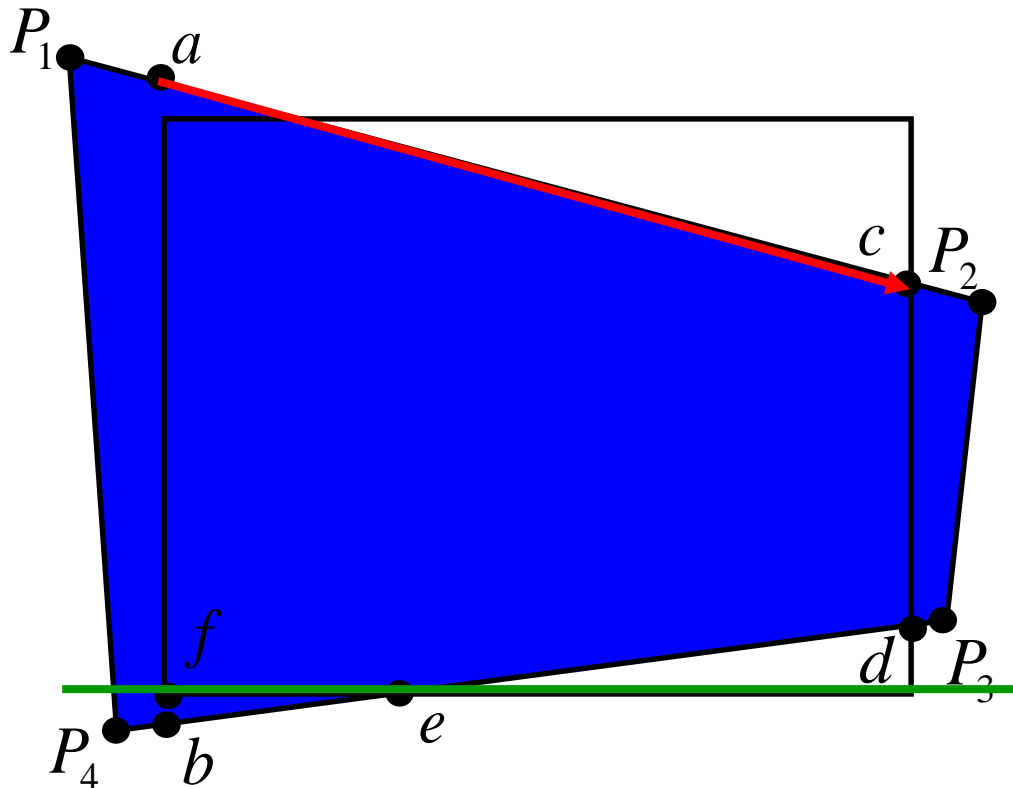
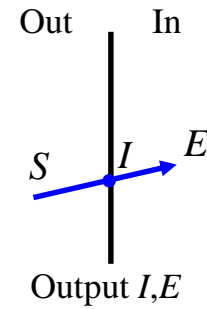
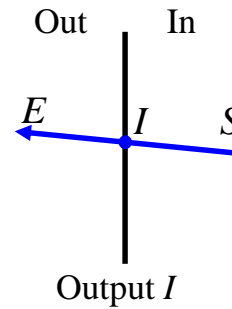
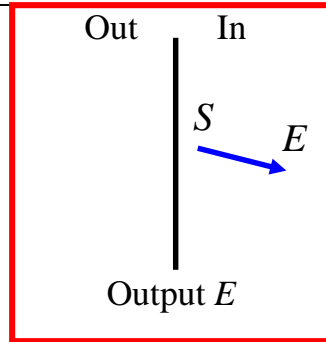
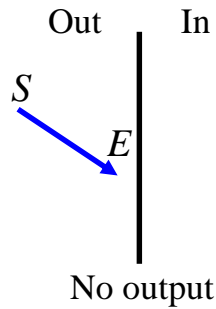

Sutherland-Hodgman Algorithm

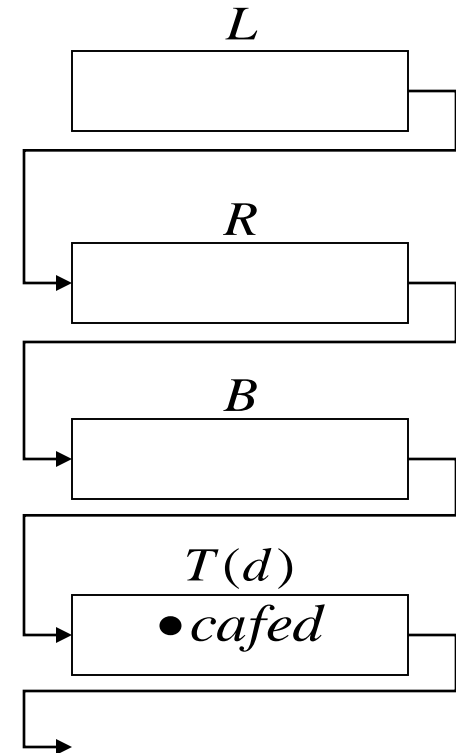
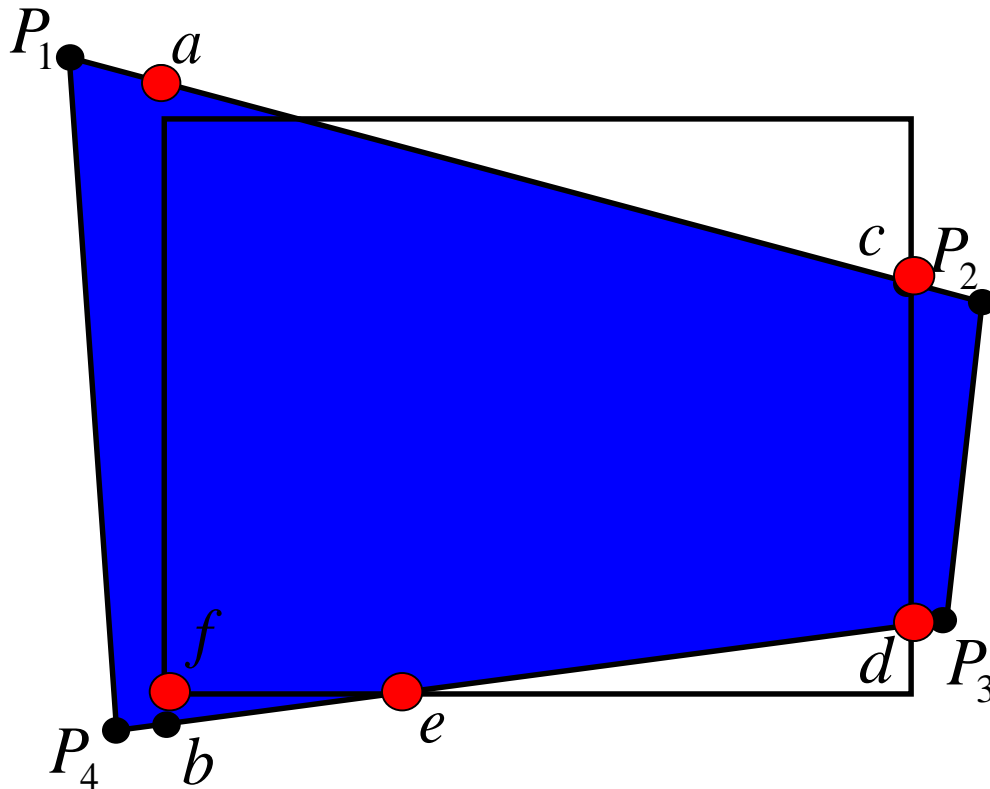
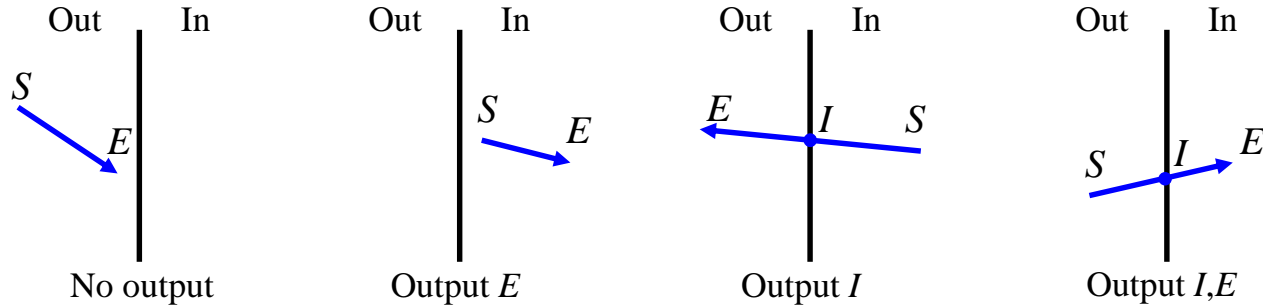

Sutherland-Hodgman Algorithm

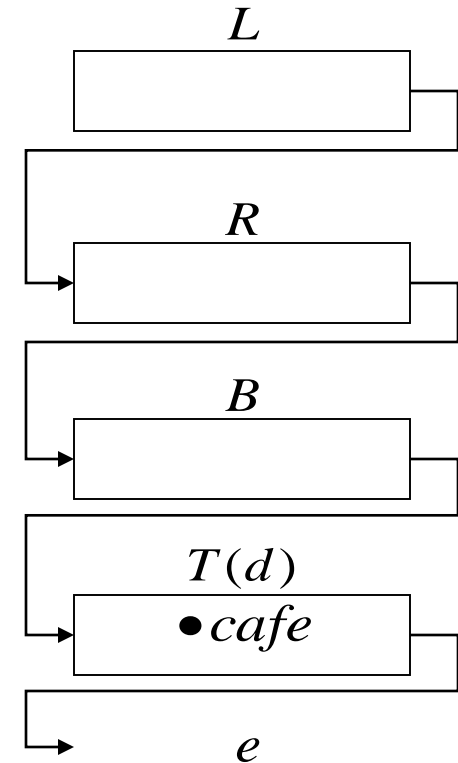
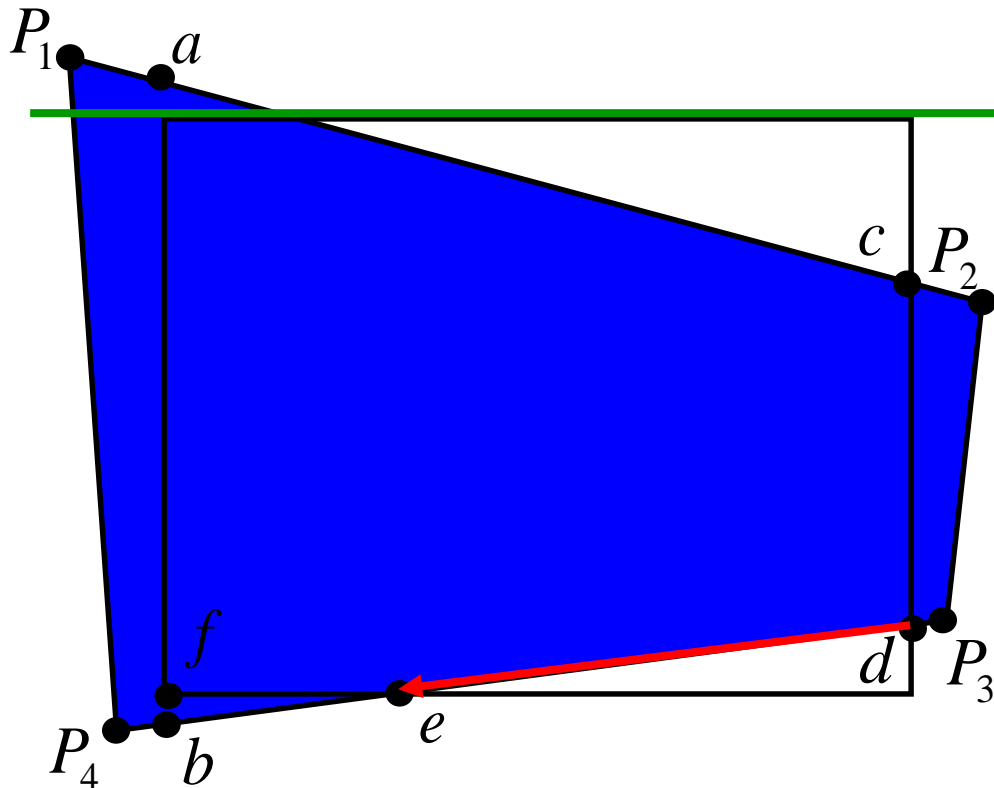
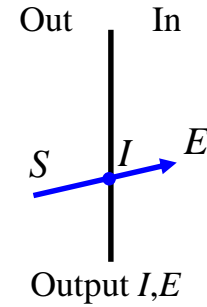
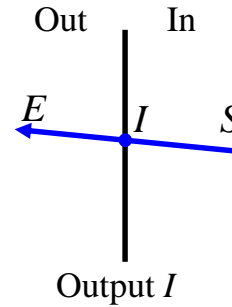
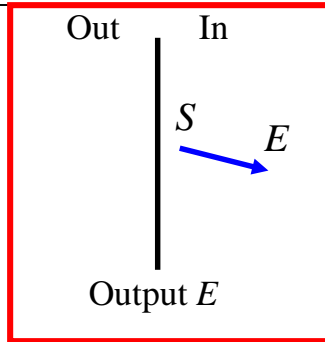
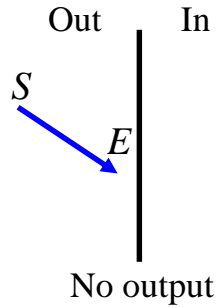

Sutherland-Hodgman Algorithm

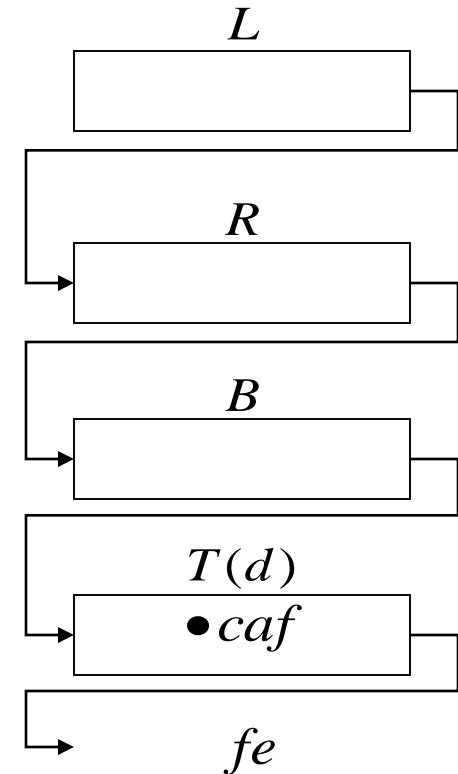
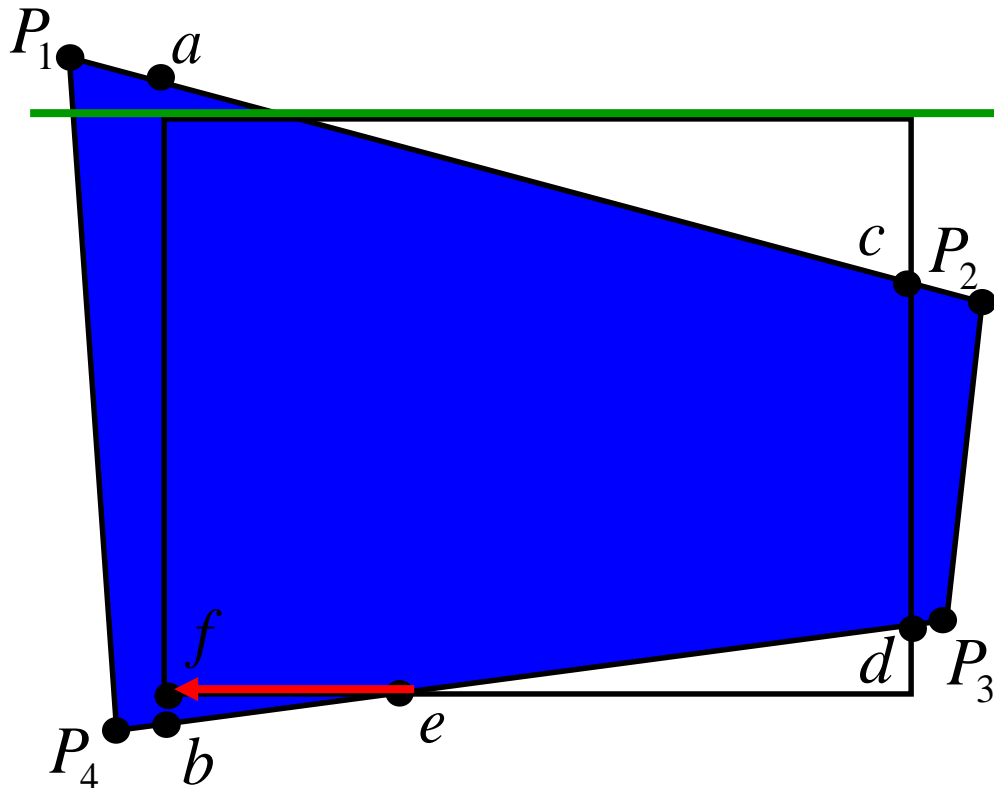
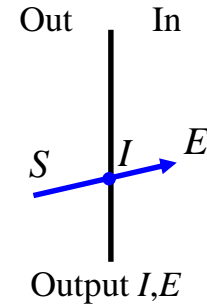
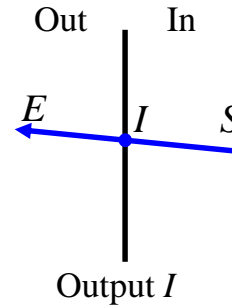
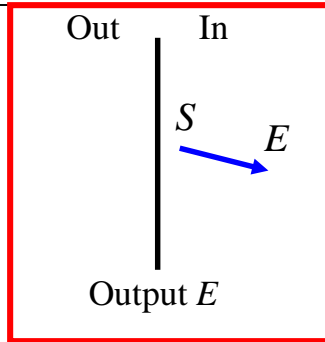
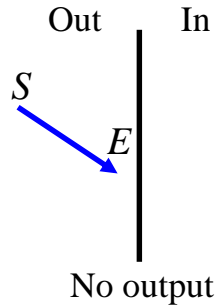

Sutherland-Hodgman Algorithm

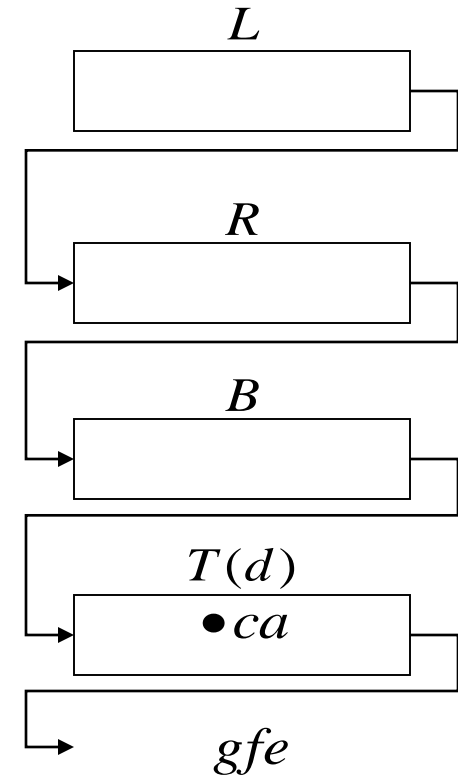
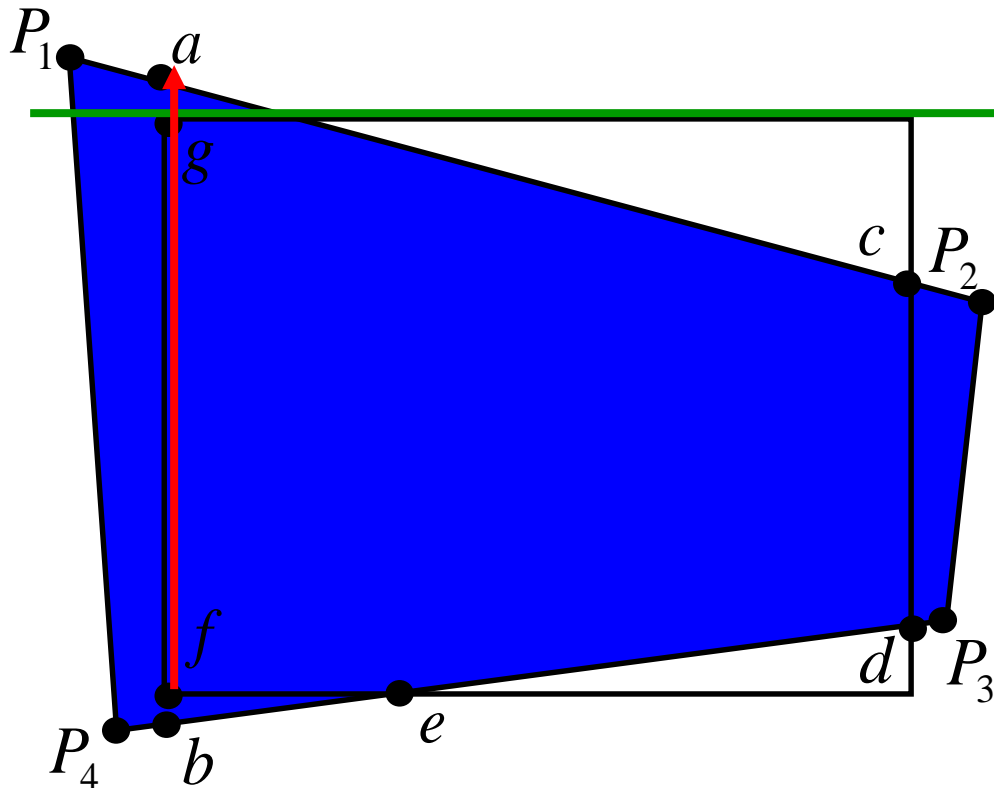
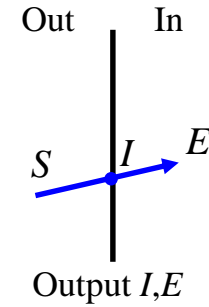
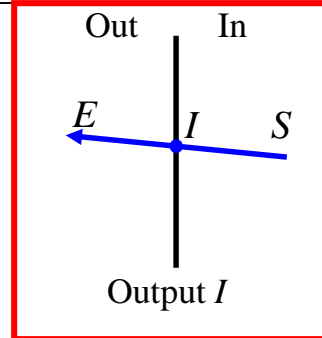
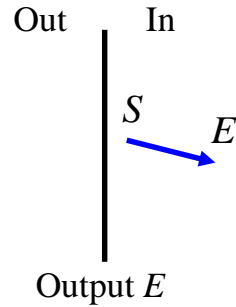
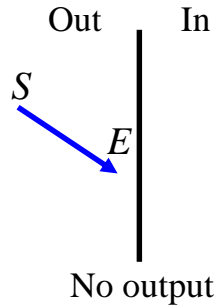

Sutherland-Hodgman Algorithm

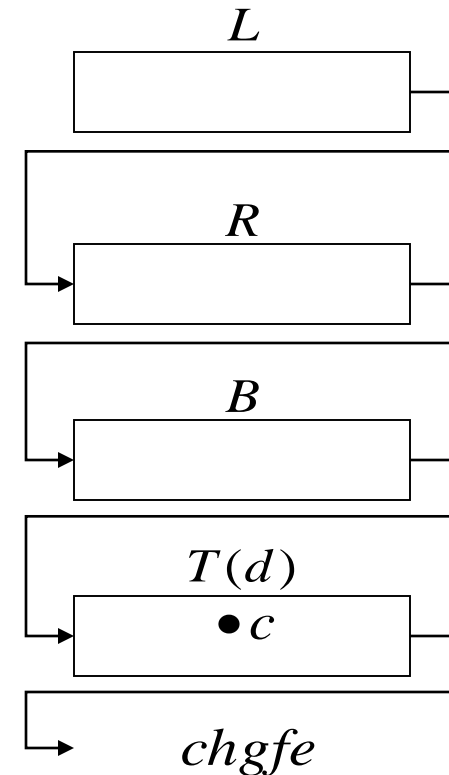
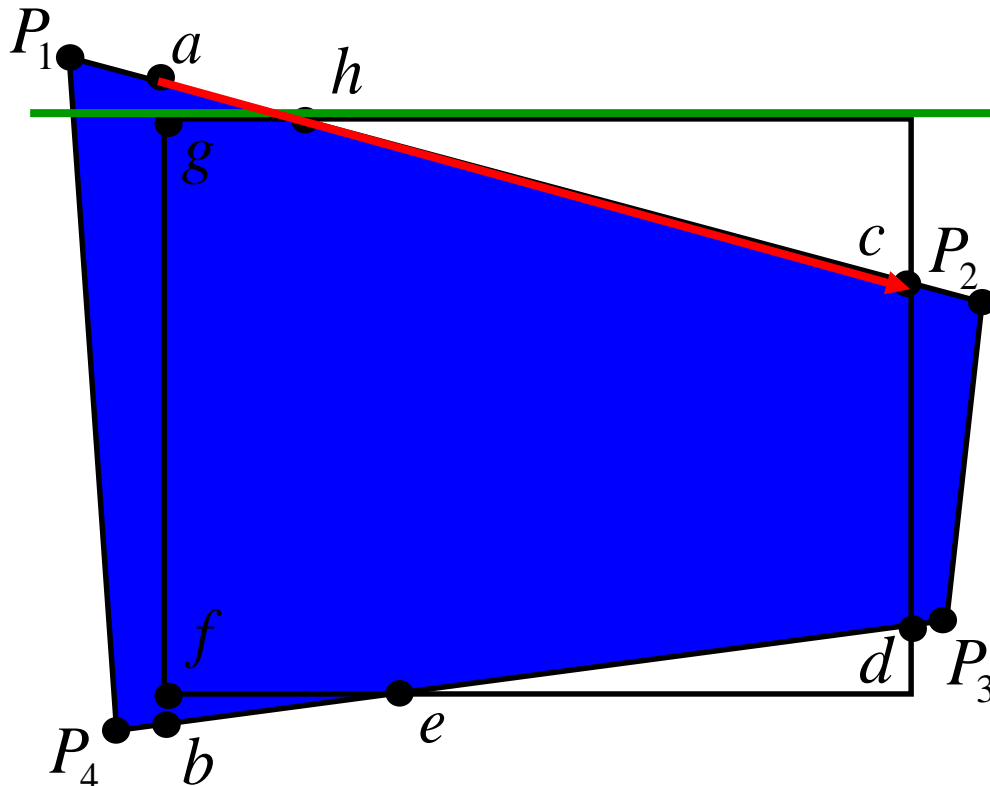
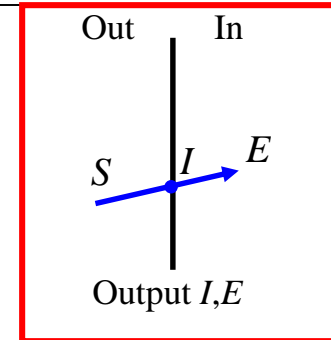
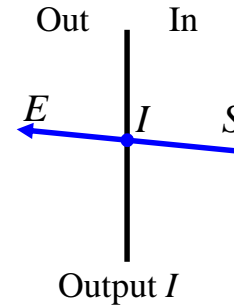
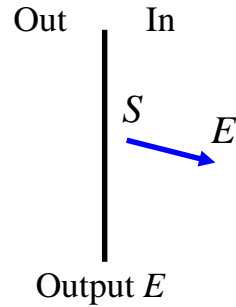
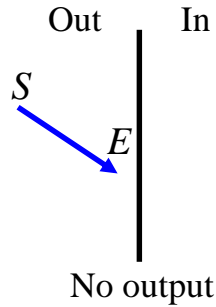

Sutherland-Hodgman Algorithm

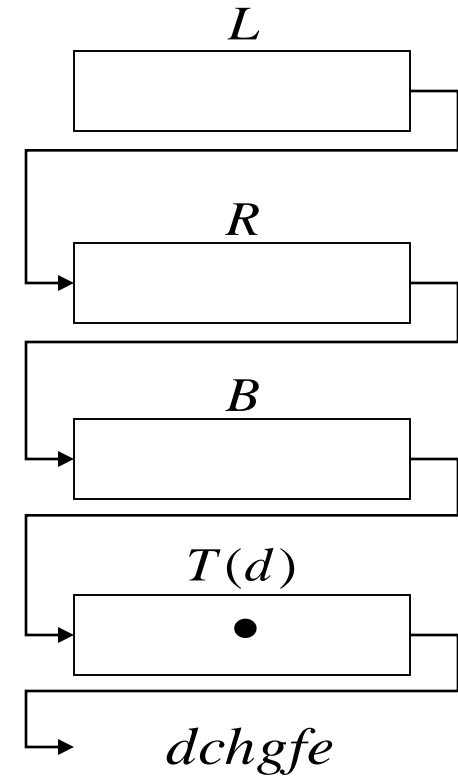
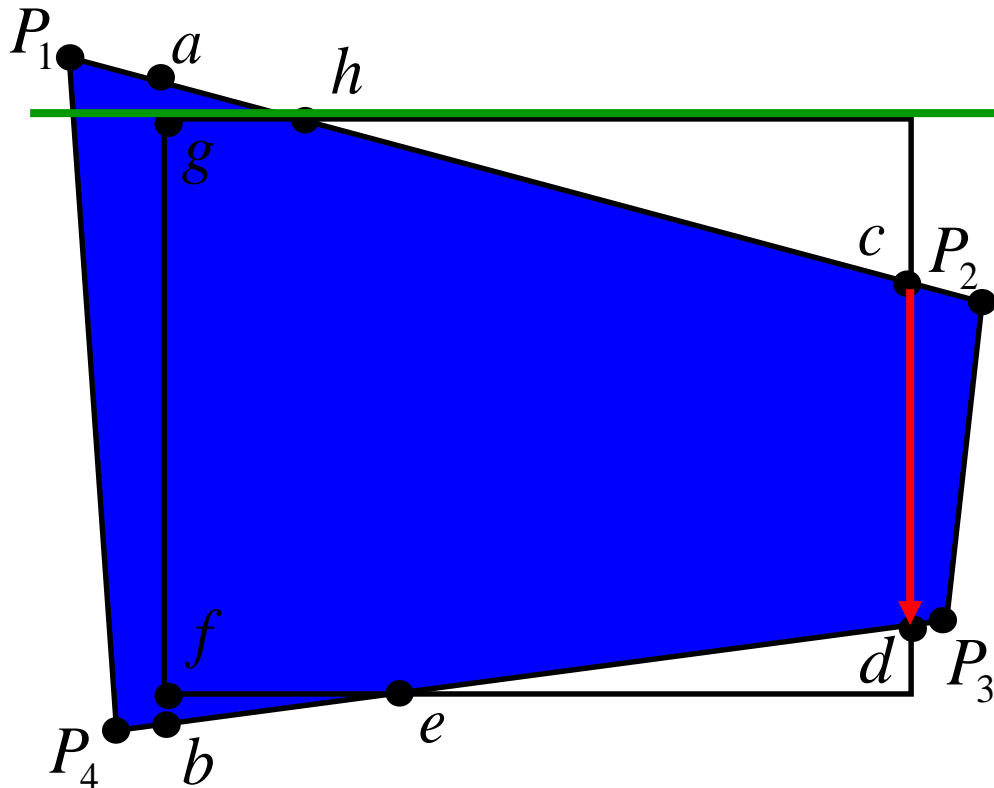
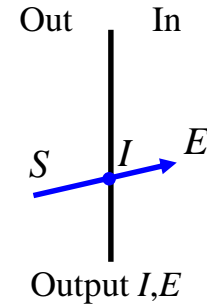
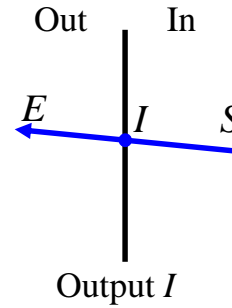
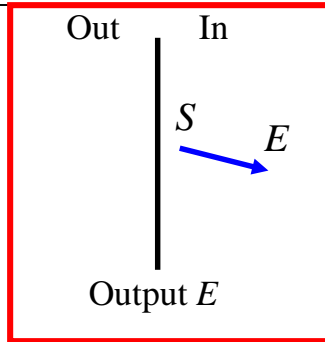
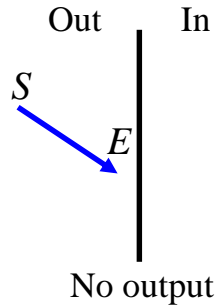

Sutherland-Hodgman Algorithm

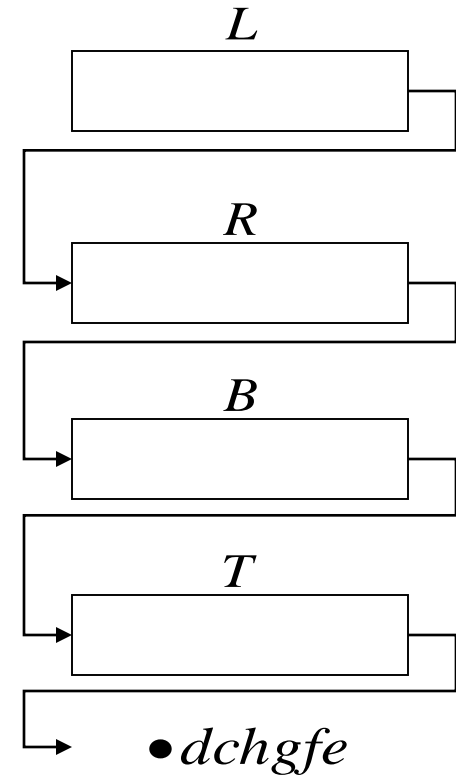
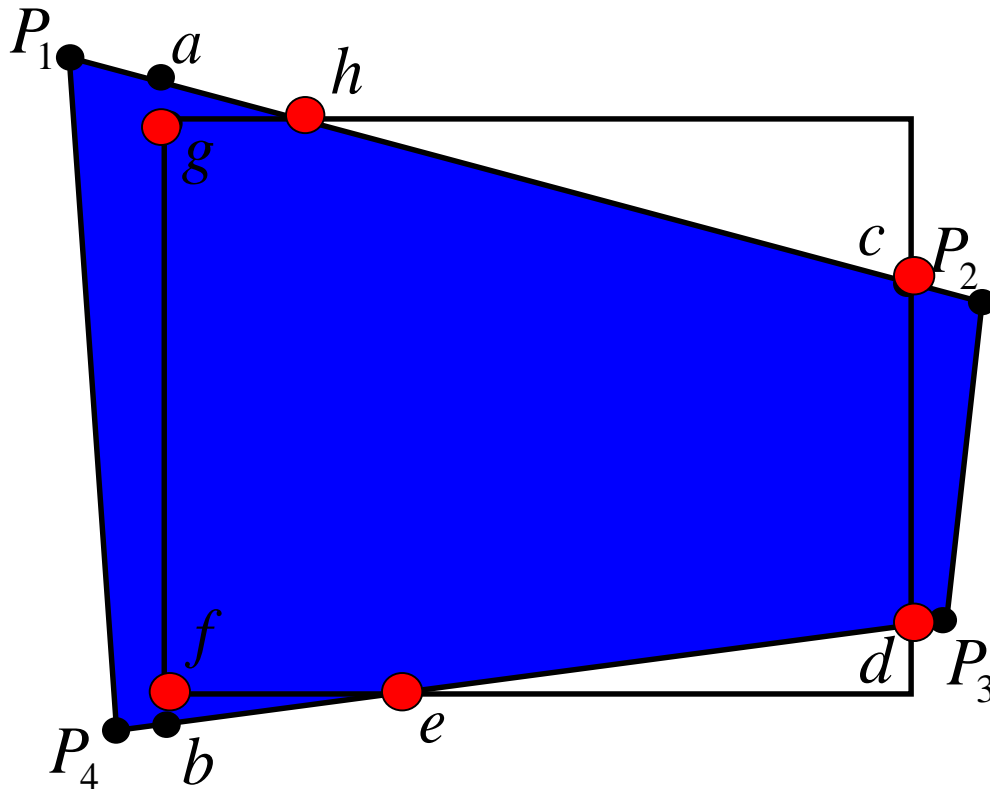
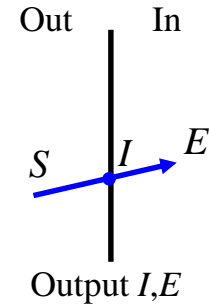
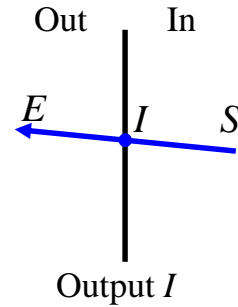
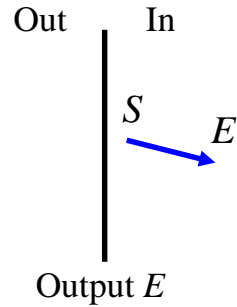
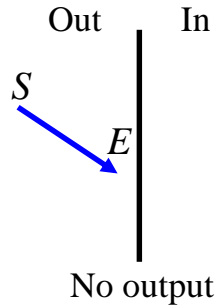

Sutherland-Hodgman Algorithm

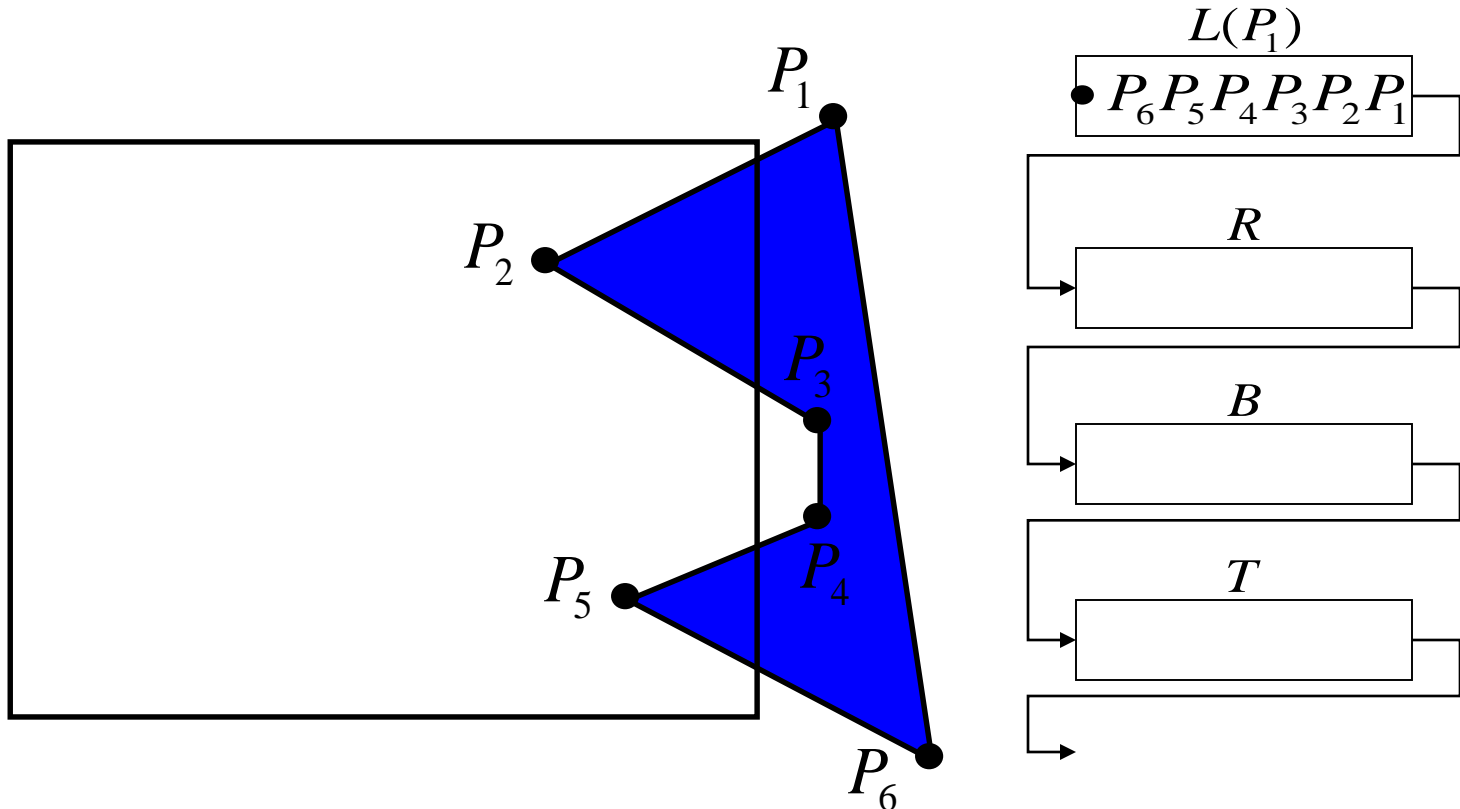
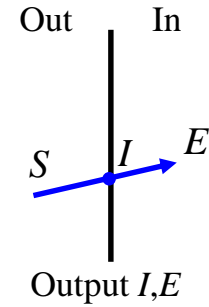
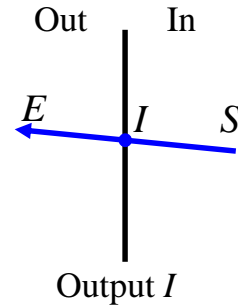
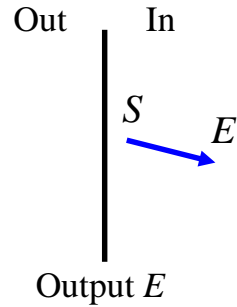
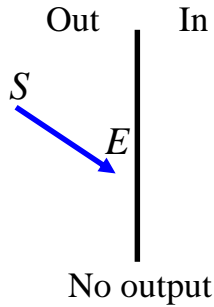

Sutherland-Hodgman Algorithm

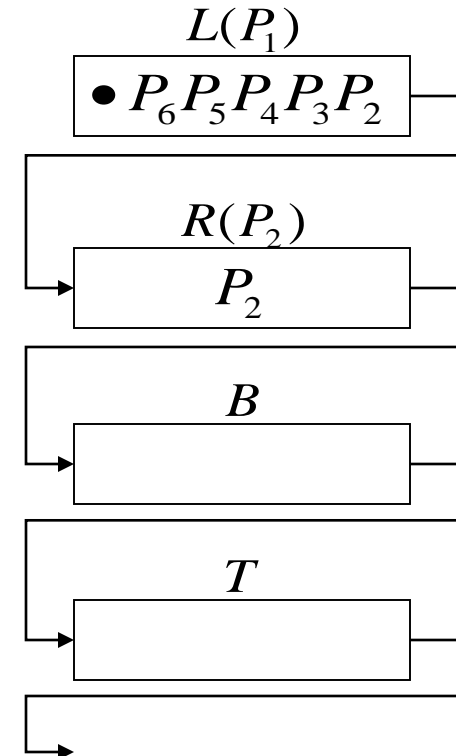
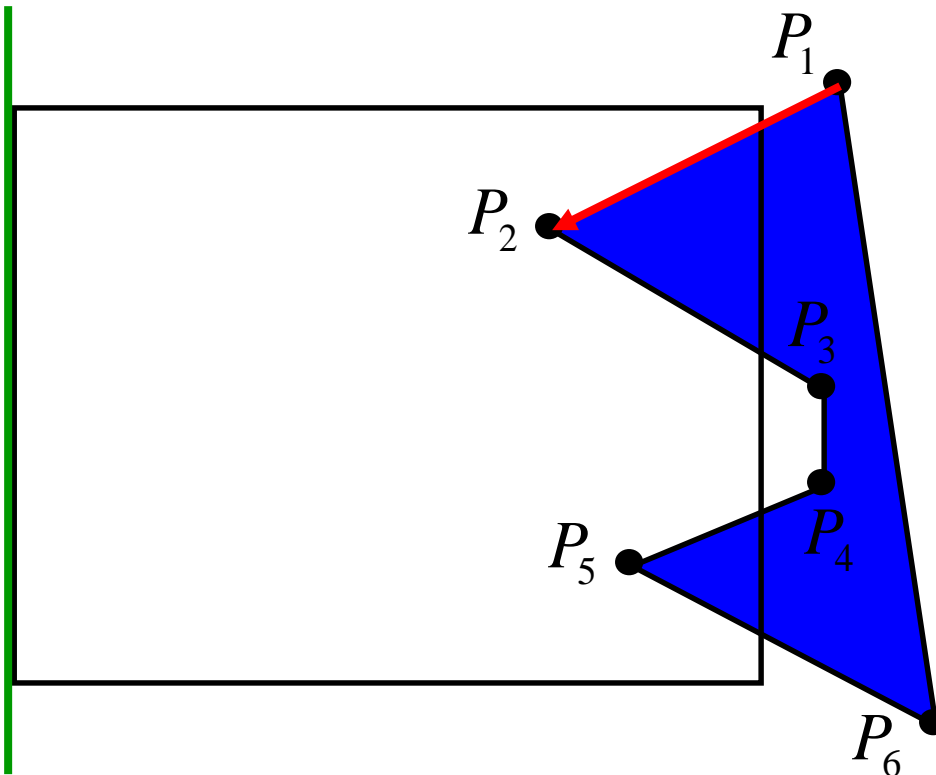
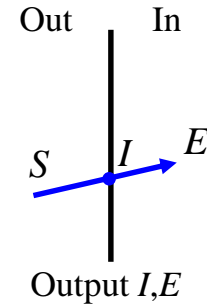
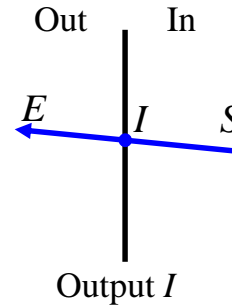
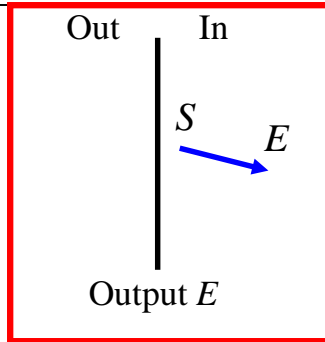
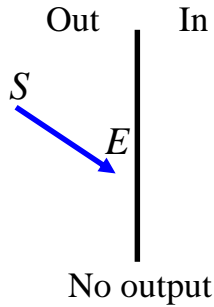

Sutherland-Hodgman Algorithm

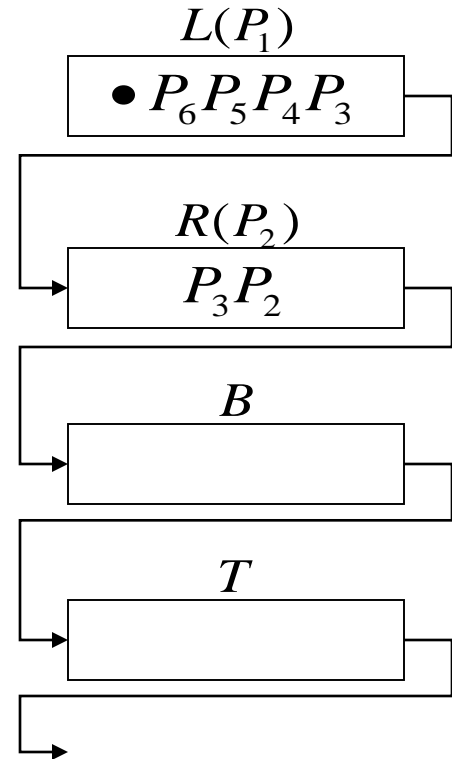
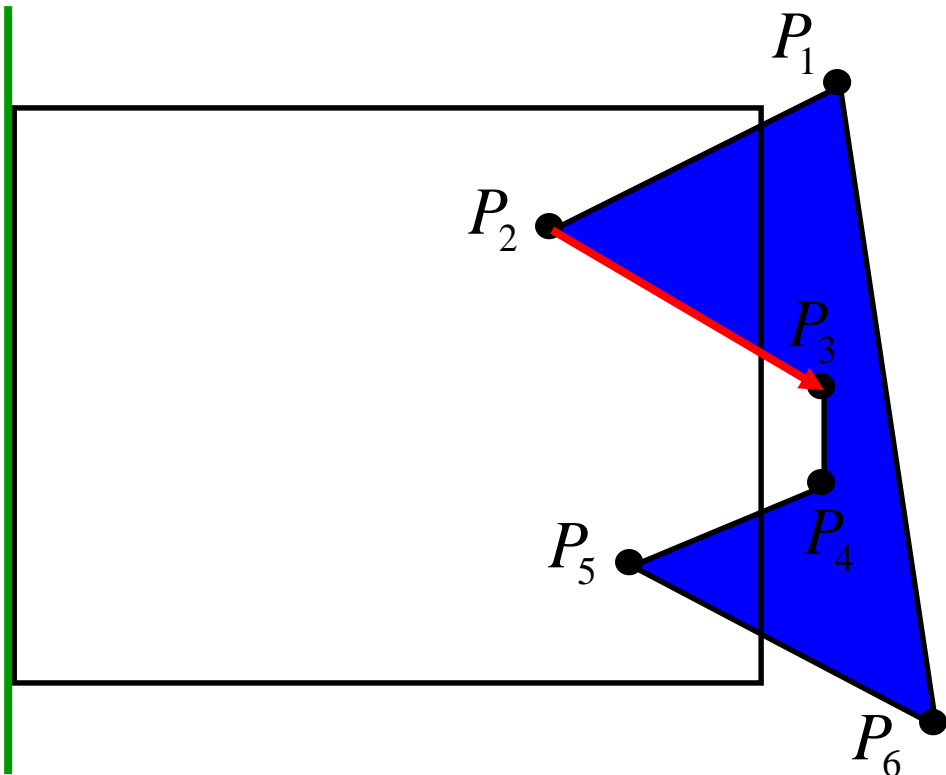
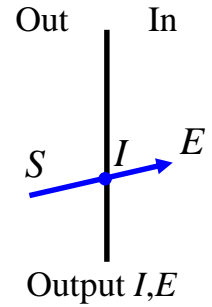
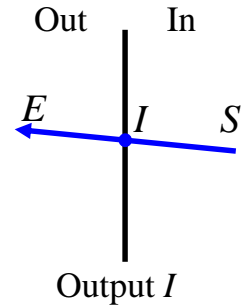
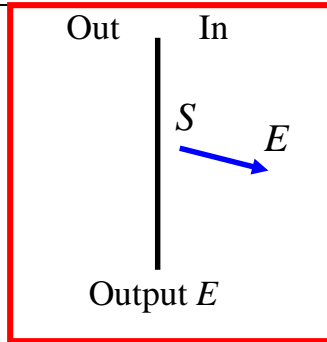
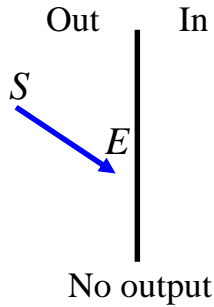

Sutherland-Hodgman Algorithm

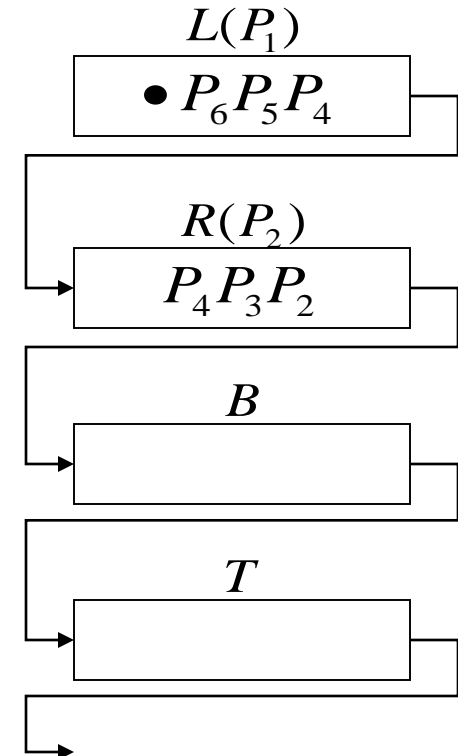
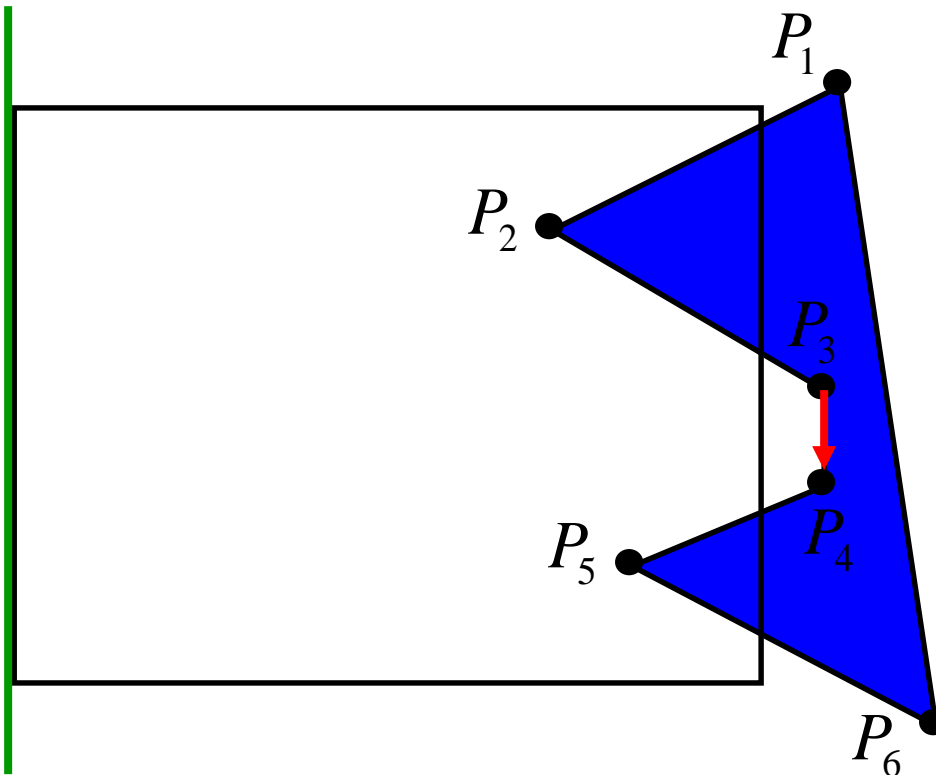
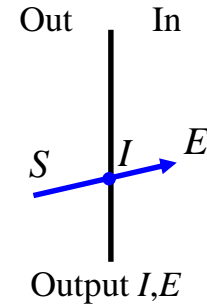
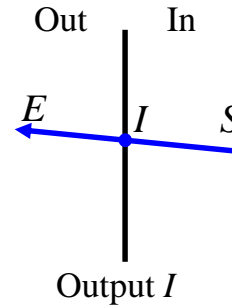
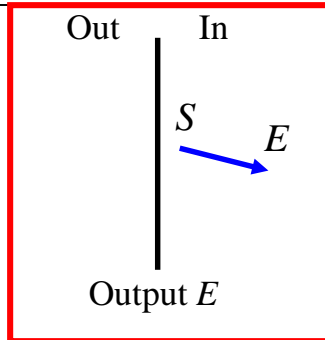
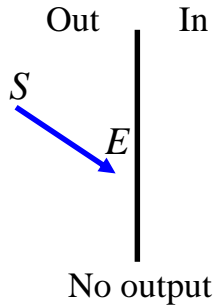

Sutherland-Hodgman Algorithm

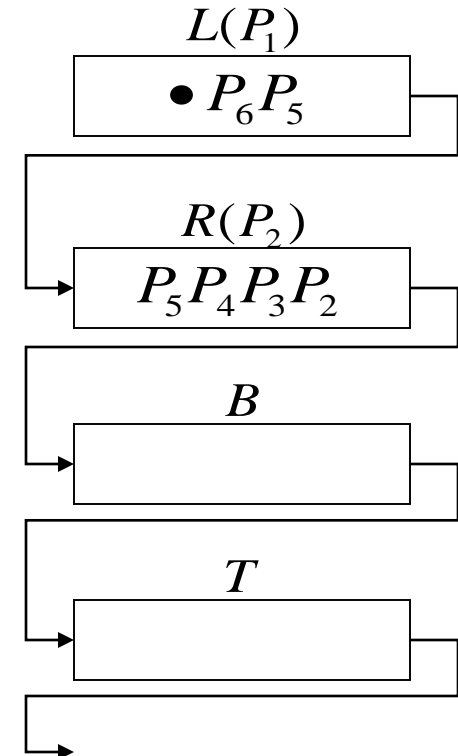
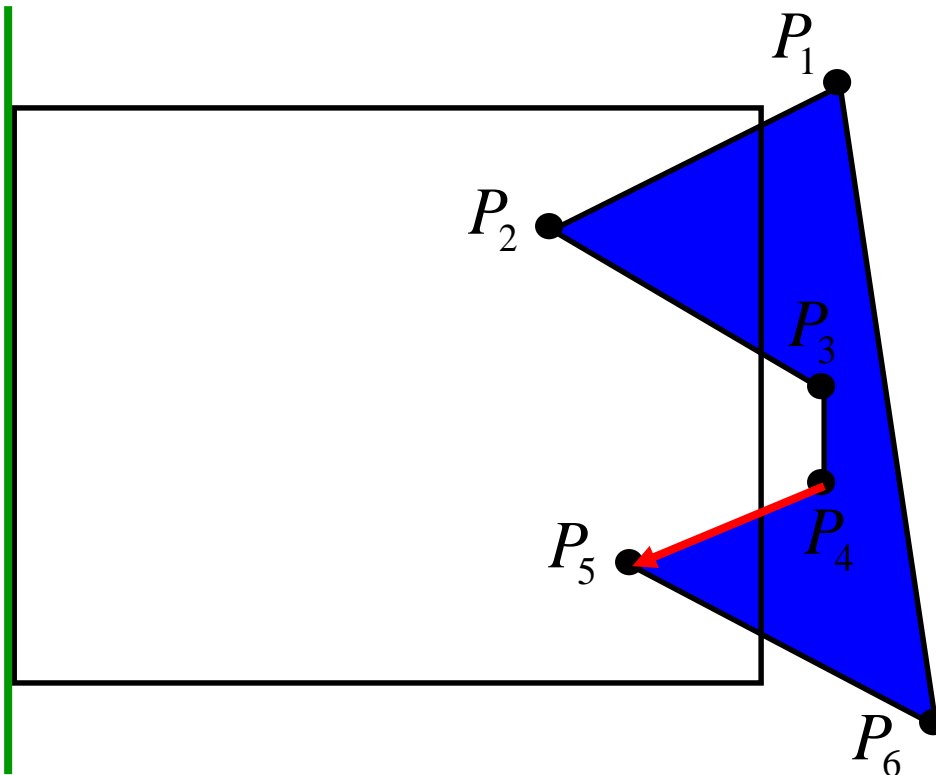
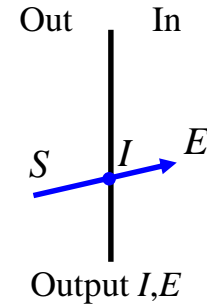
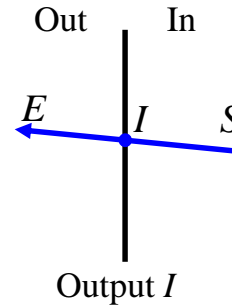
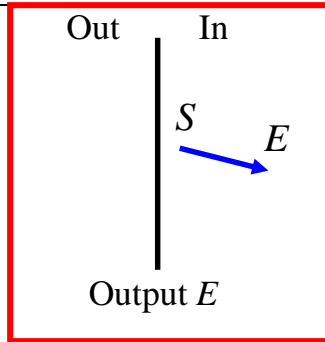
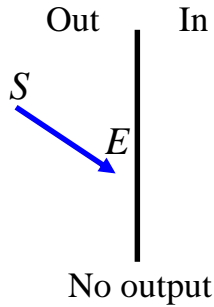

Sutherland-Hodgman Algorithm

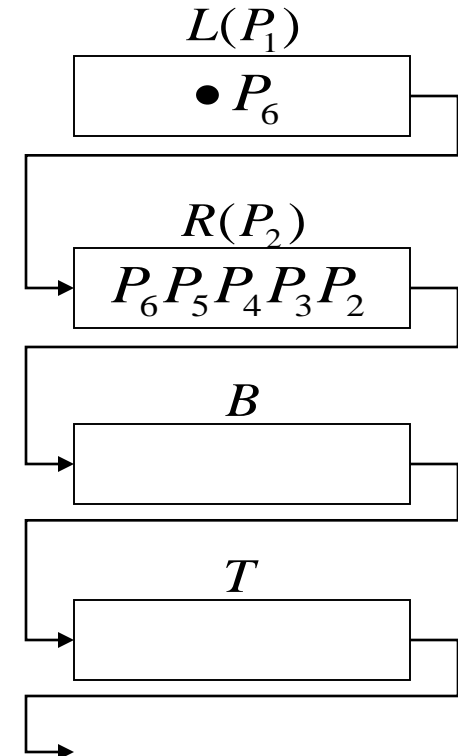
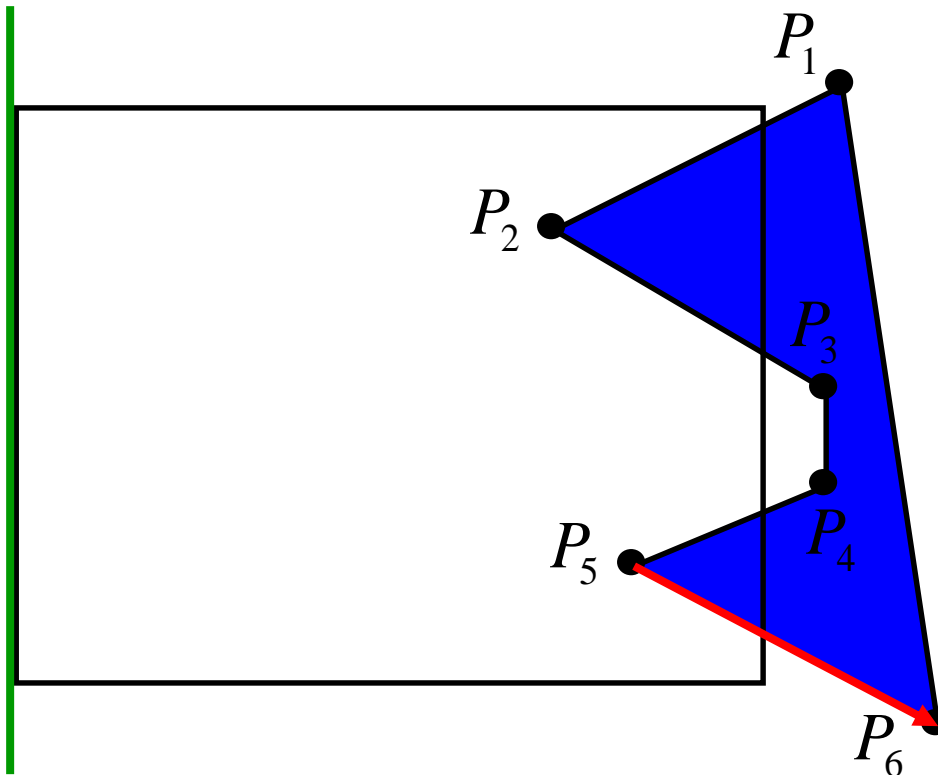
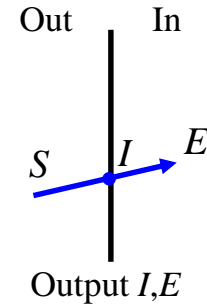
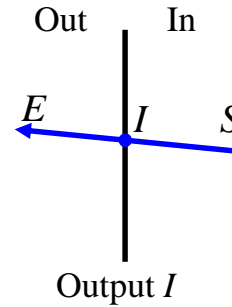
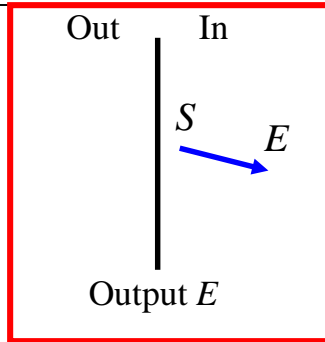
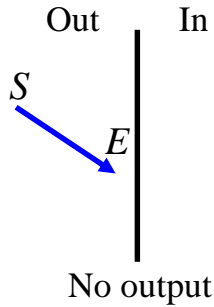

Sutherland-Hodgman Algorithm

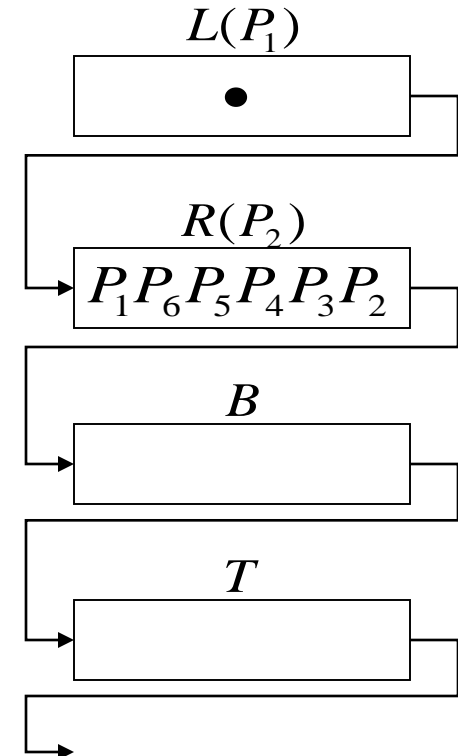
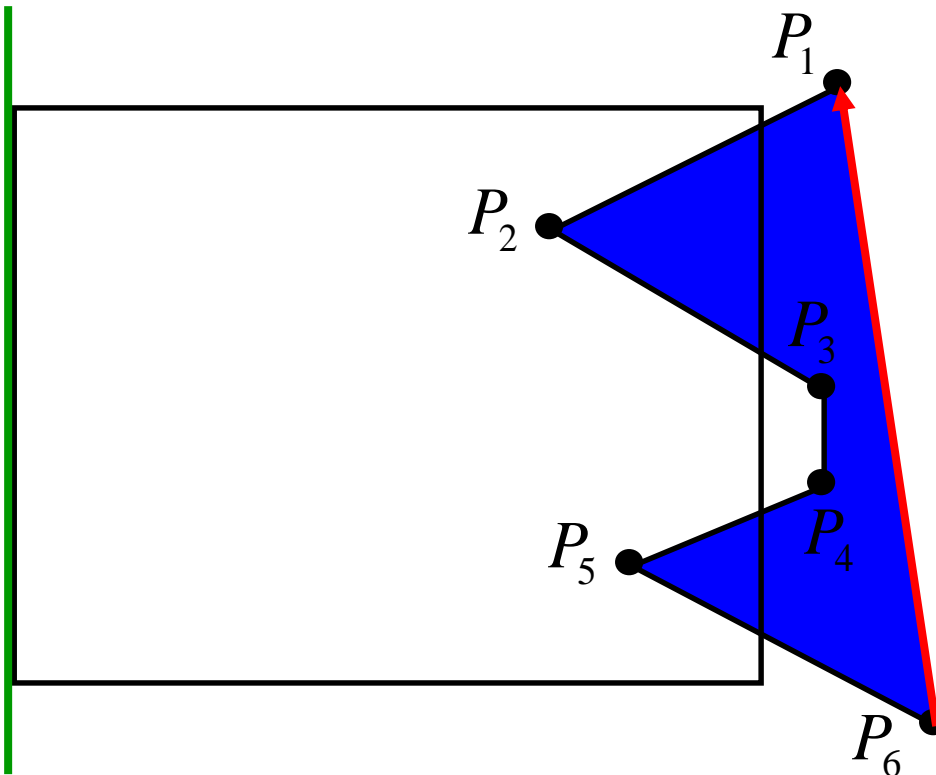
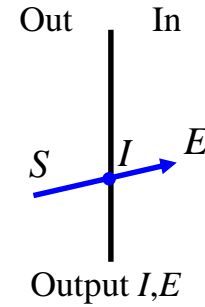
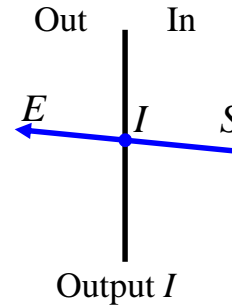
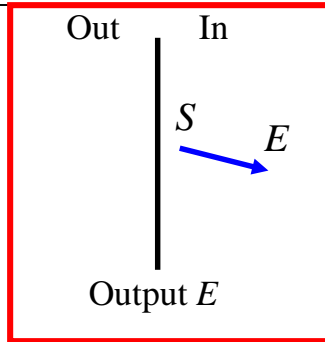
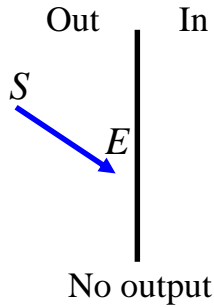

Sutherland-Hodgman Algorithm

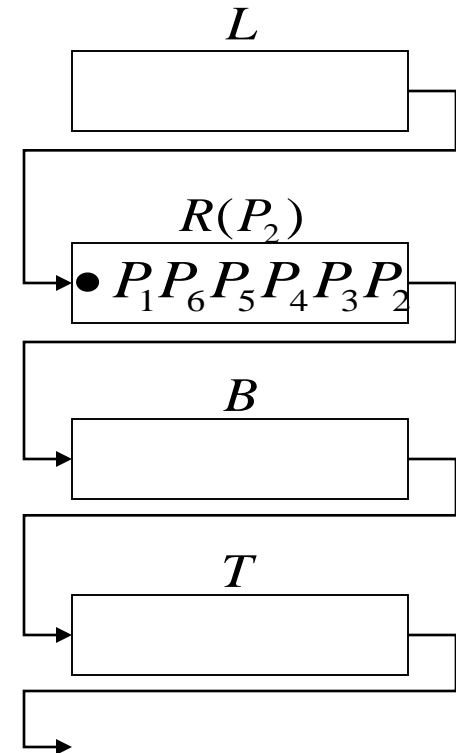
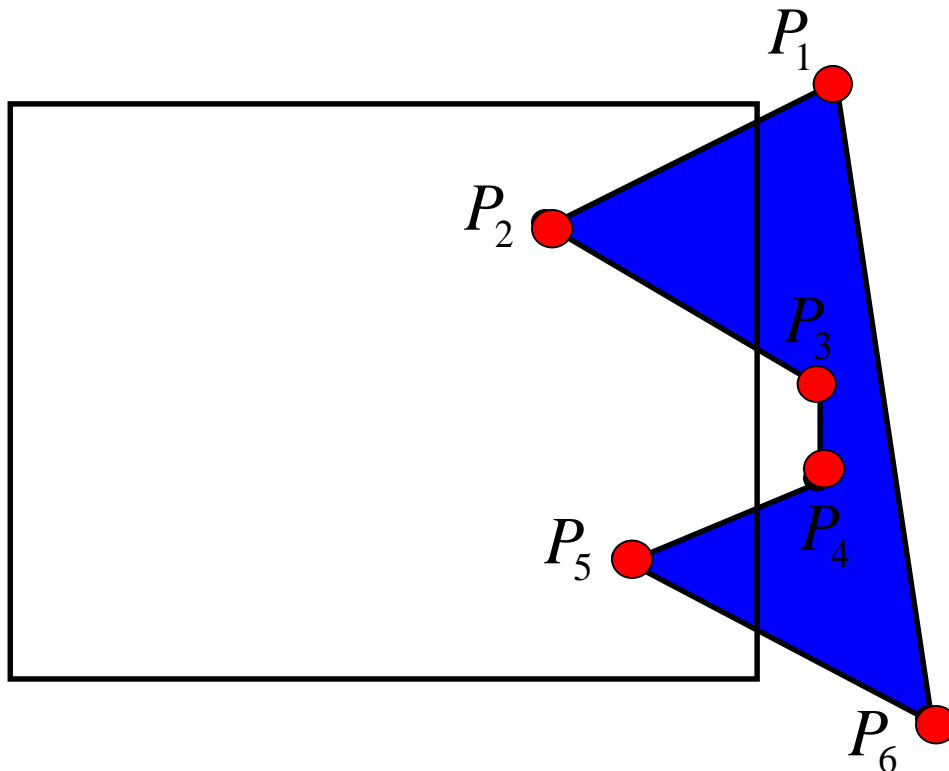
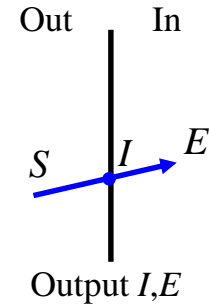
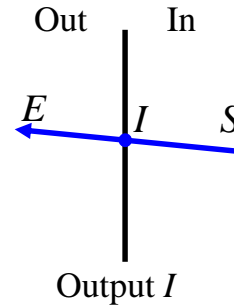
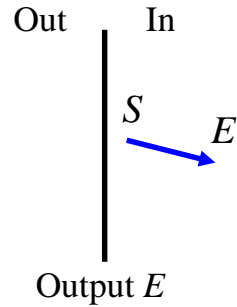
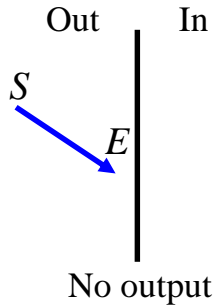

Sutherland-Hodgman Algorithm

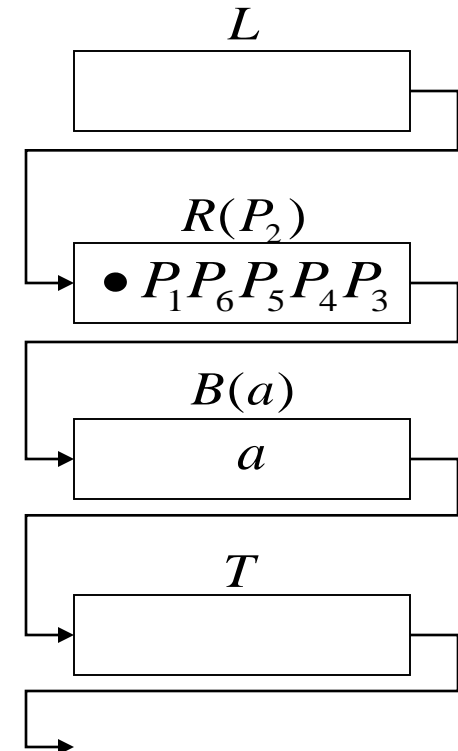
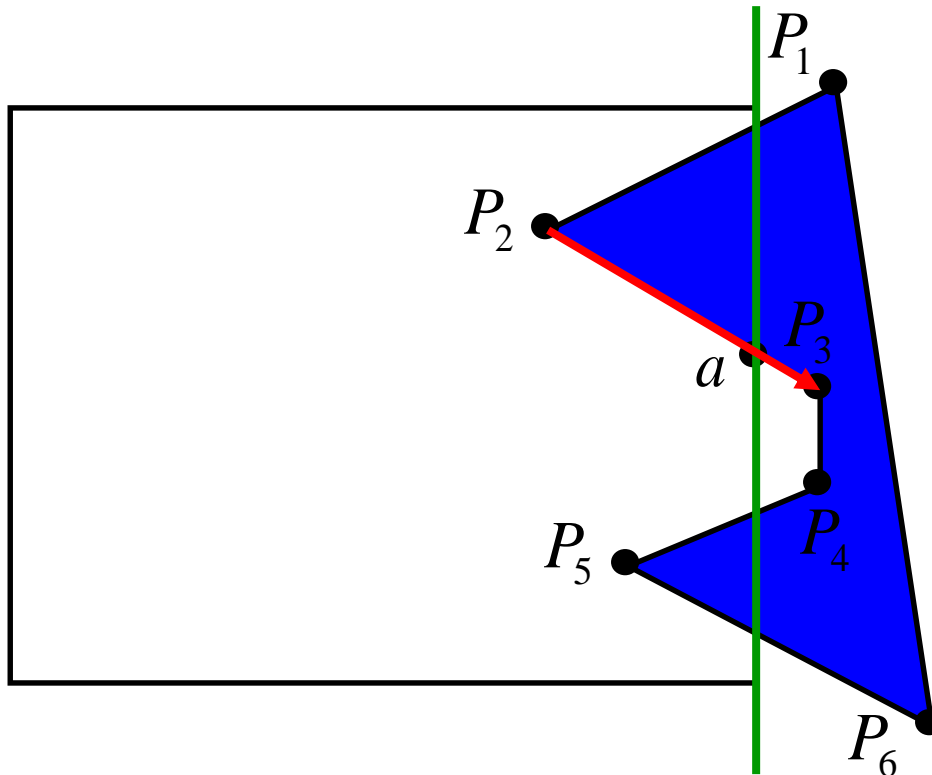
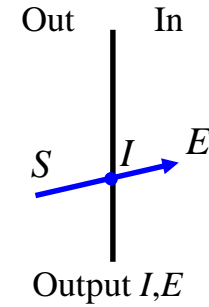
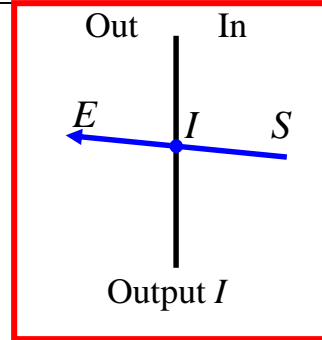
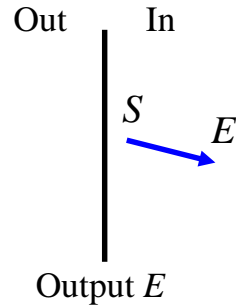
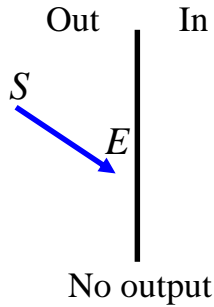

Sutherland-Hodgman Algorithm

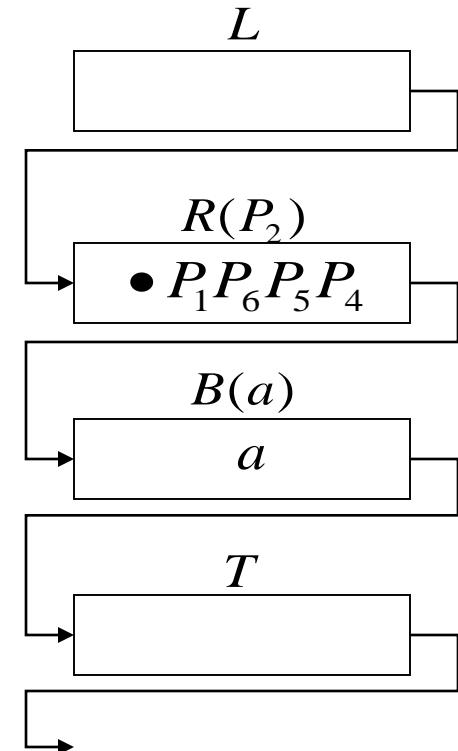
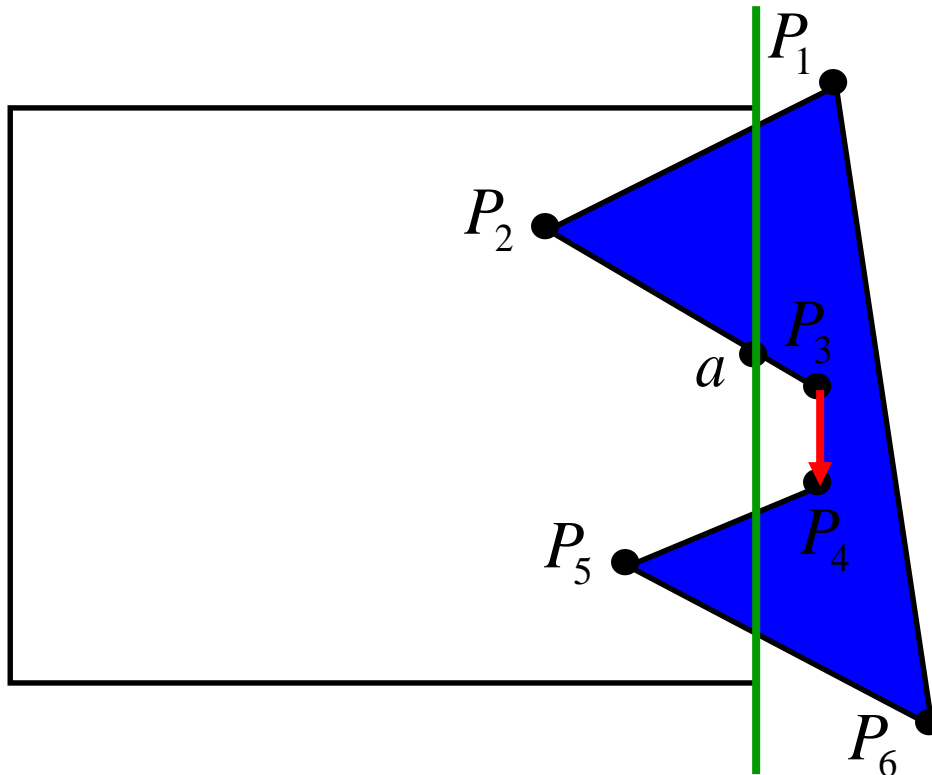
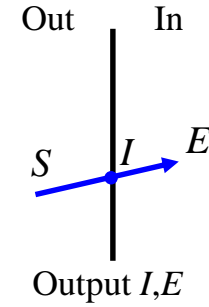
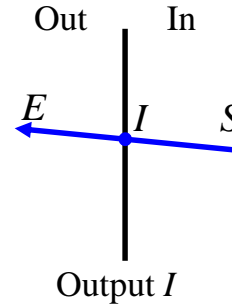
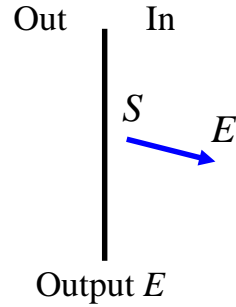
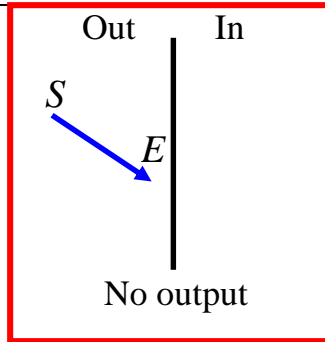

Sutherland-Hodgman Algorithm

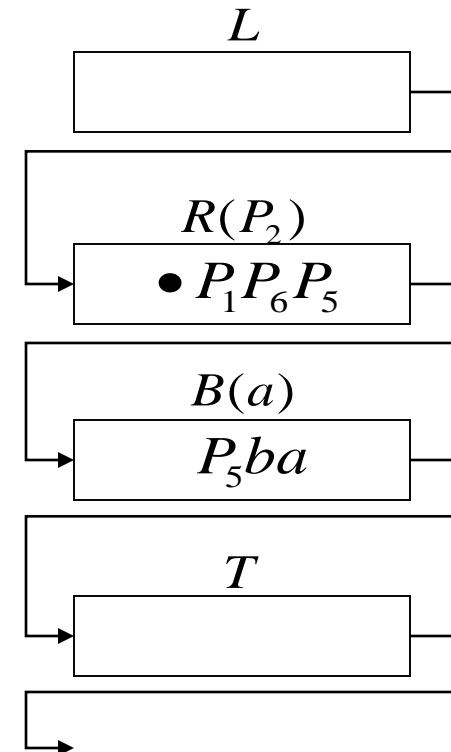
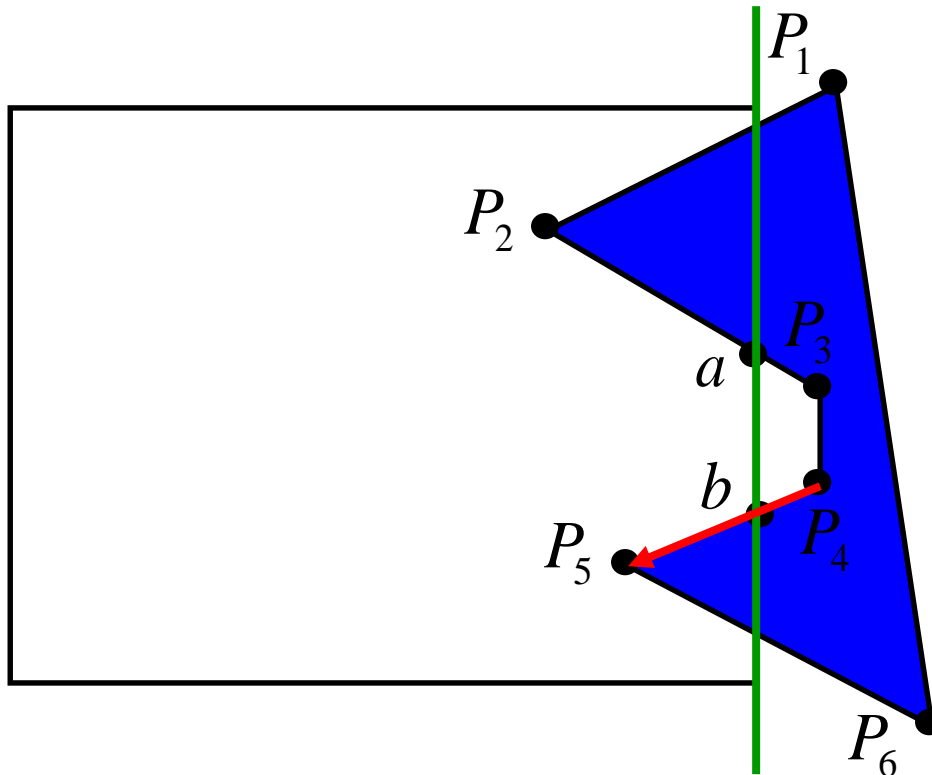
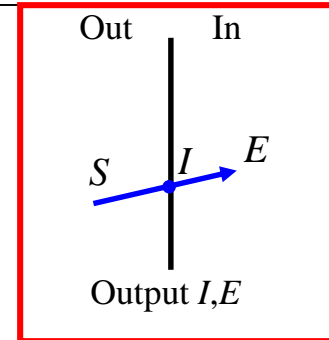
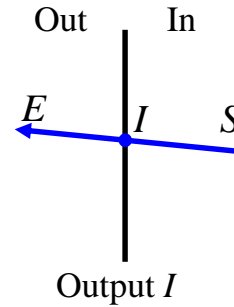
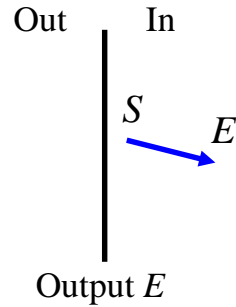
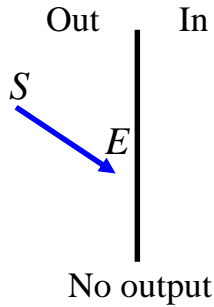

Sutherland-Hodgman Algorithm

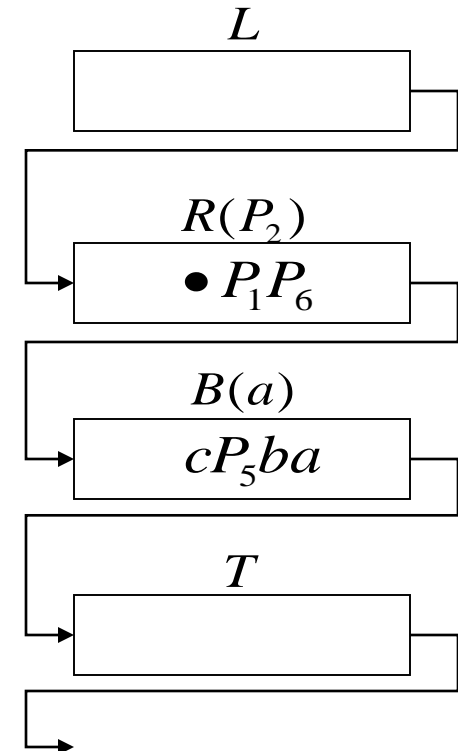
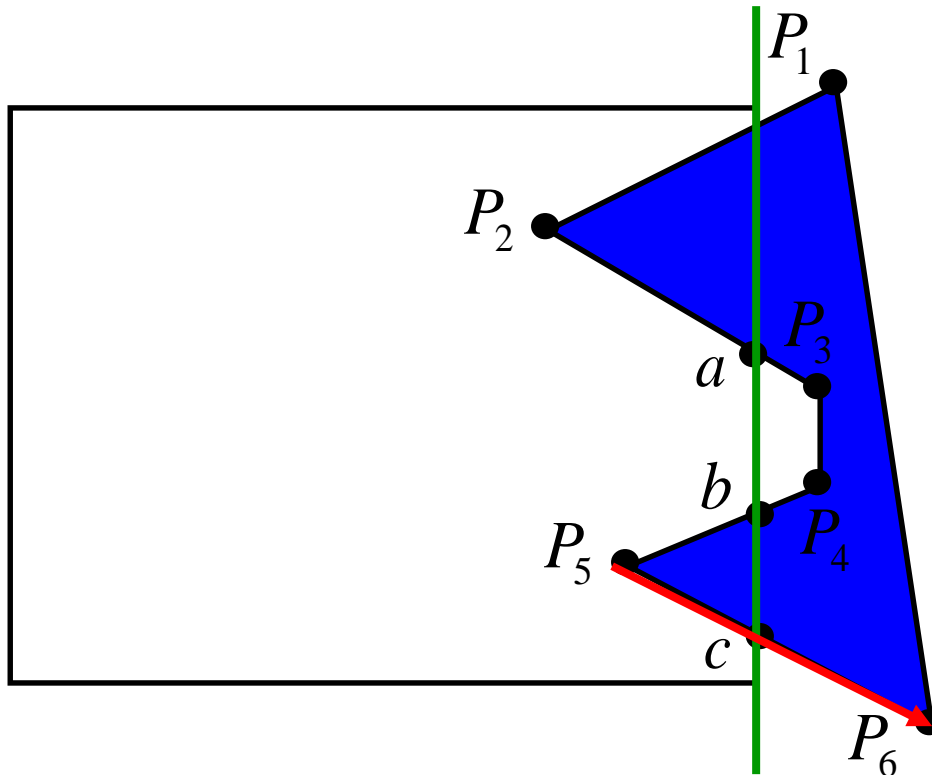
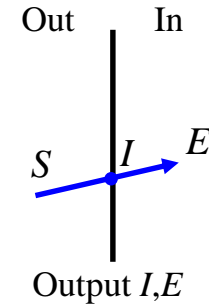
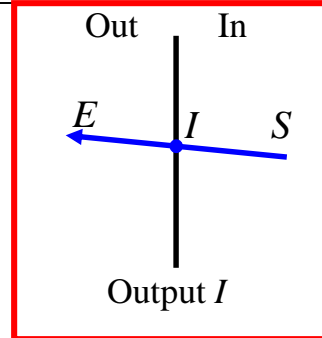
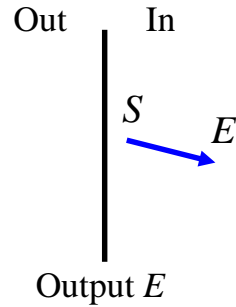
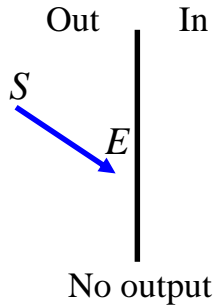

Sutherland-Hodgman Algorithm

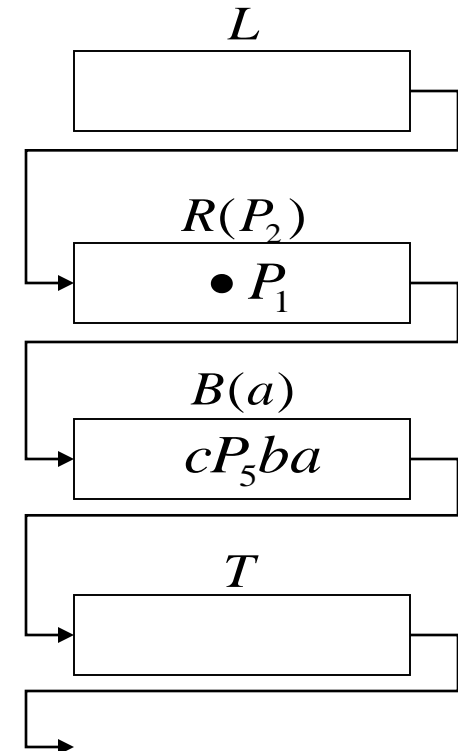
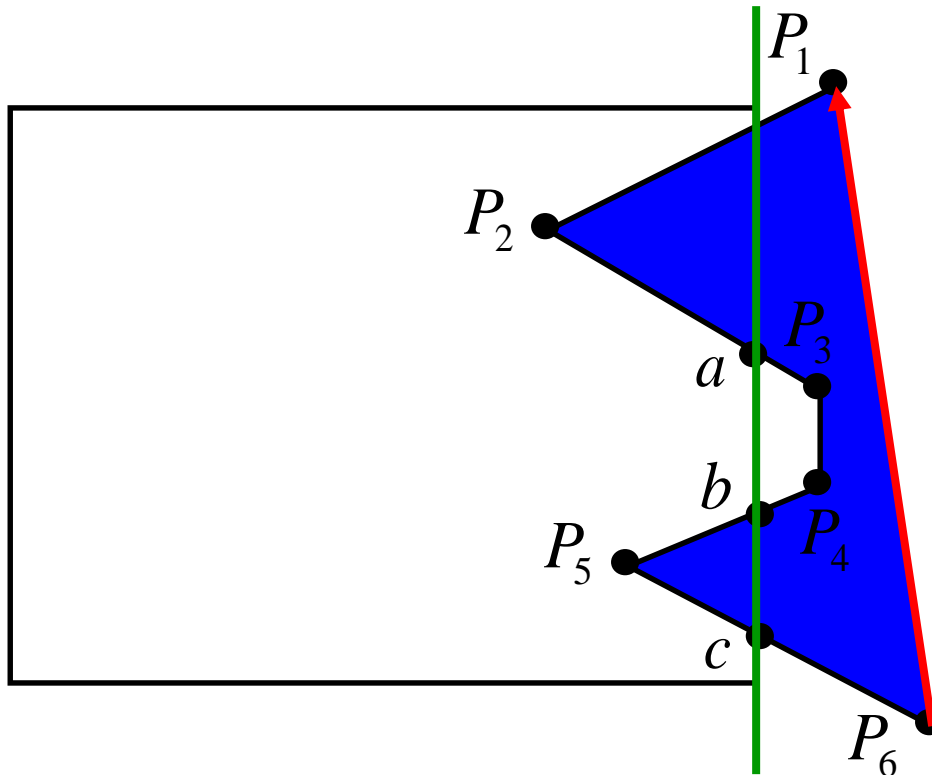
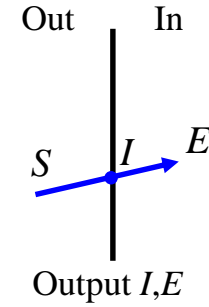
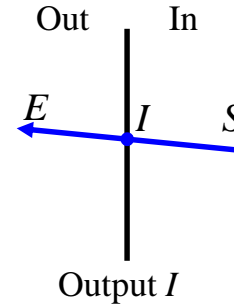
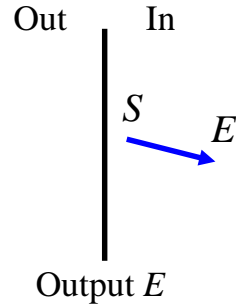
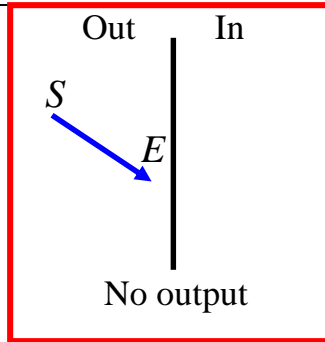

Sutherland-Hodgman Algorithm

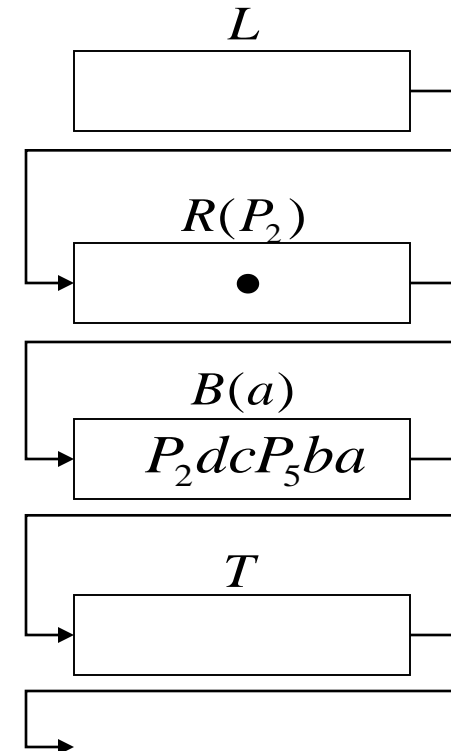
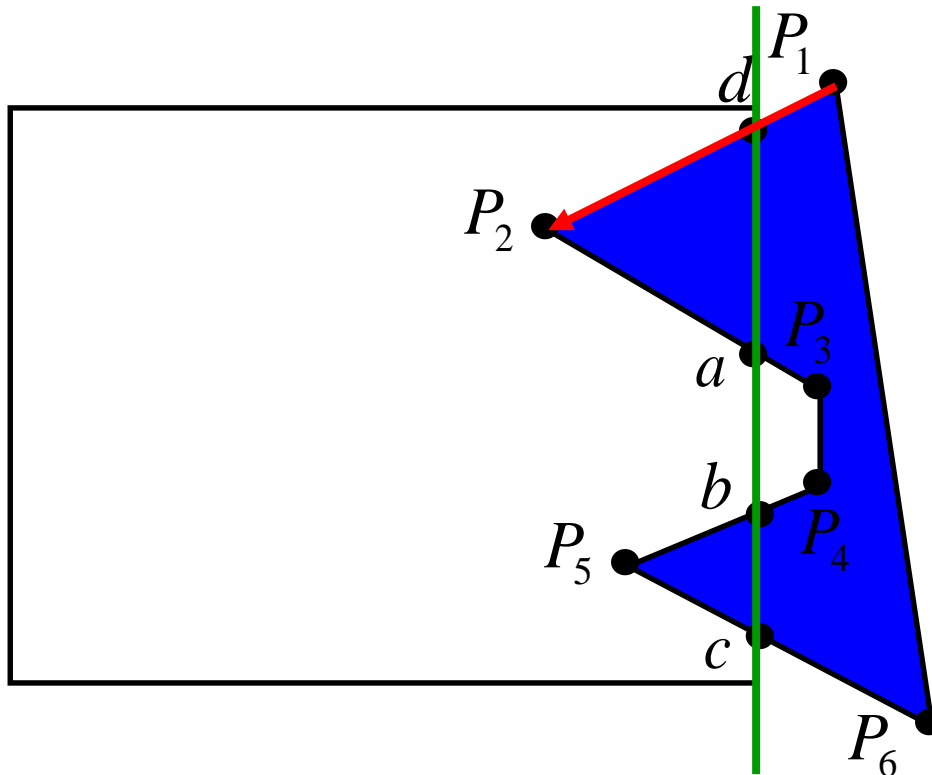
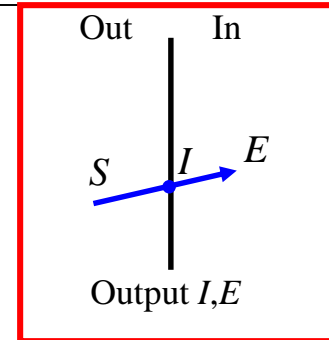
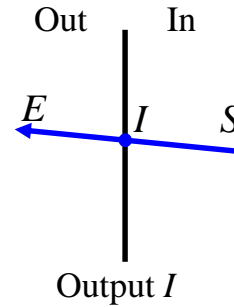
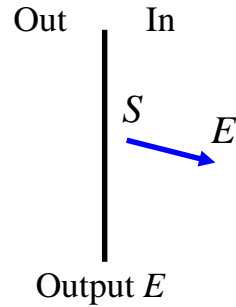
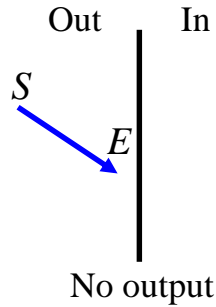

Sutherland-Hodgman Algorithm

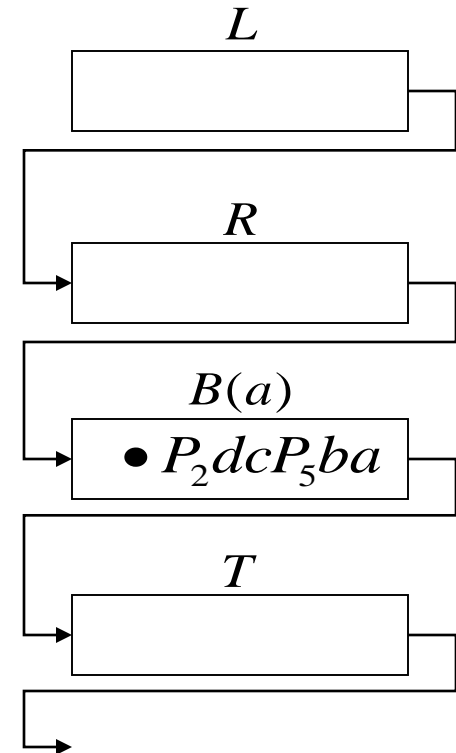
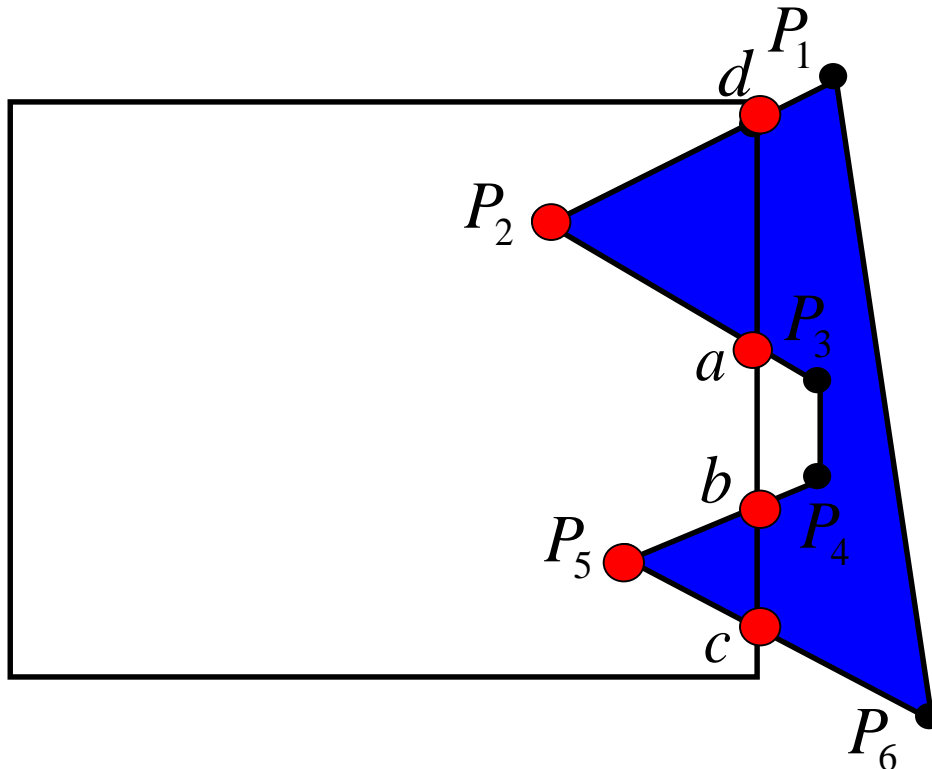
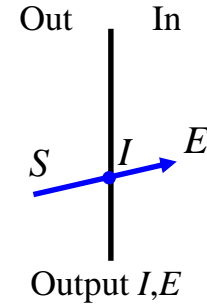
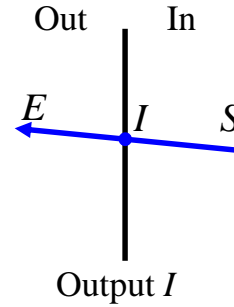
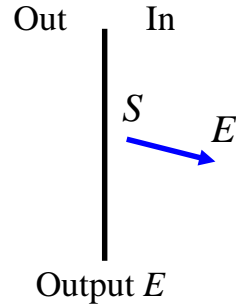
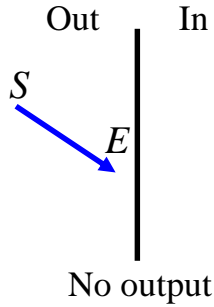

Sutherland-Hodgman Algorithm

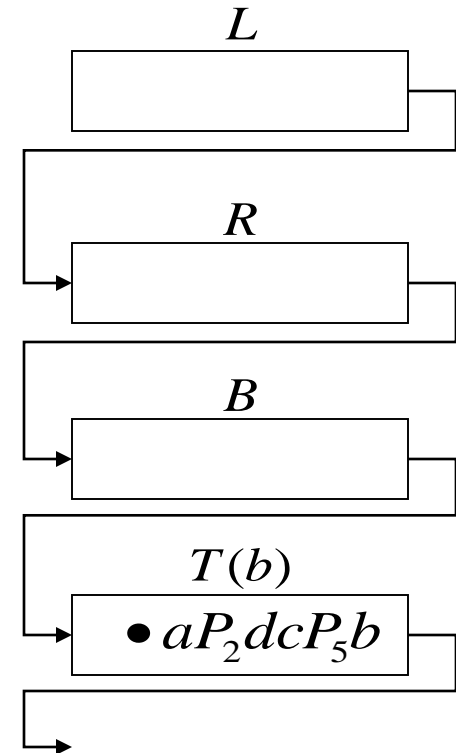
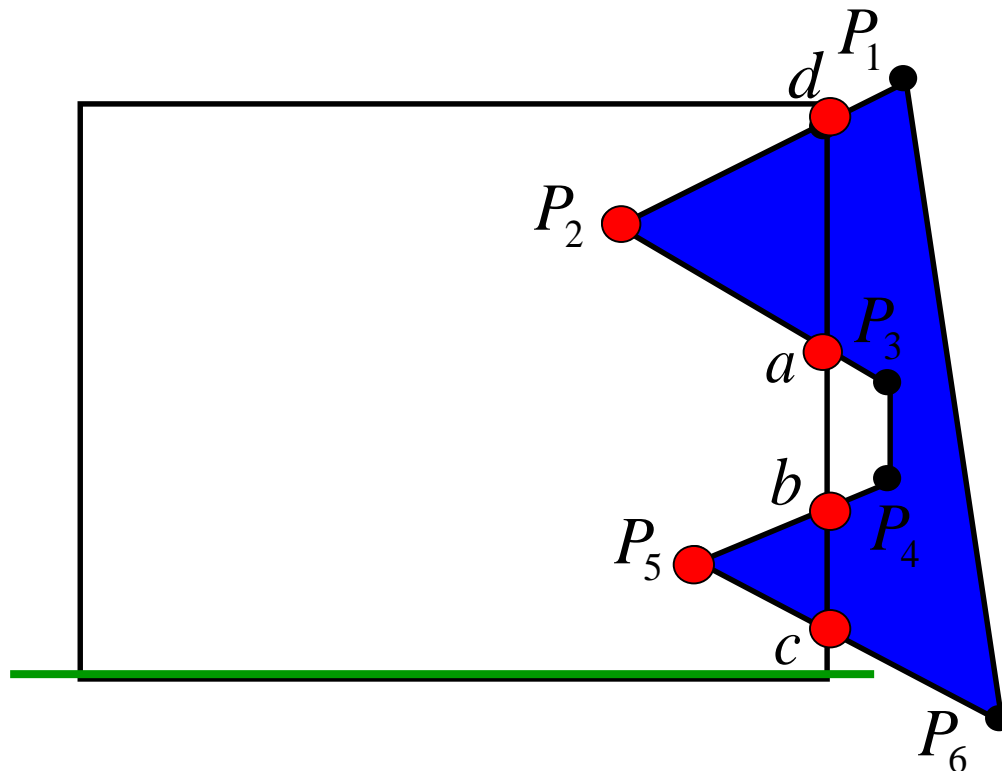
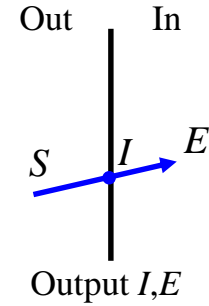
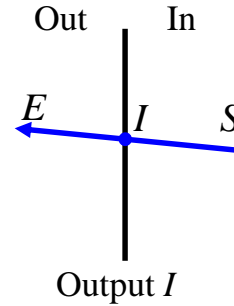
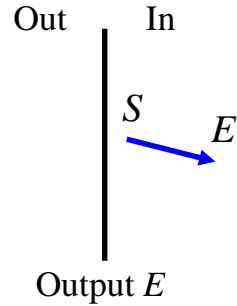
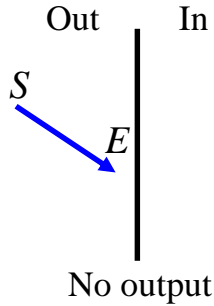

Sutherland-Hodgman Algorithm

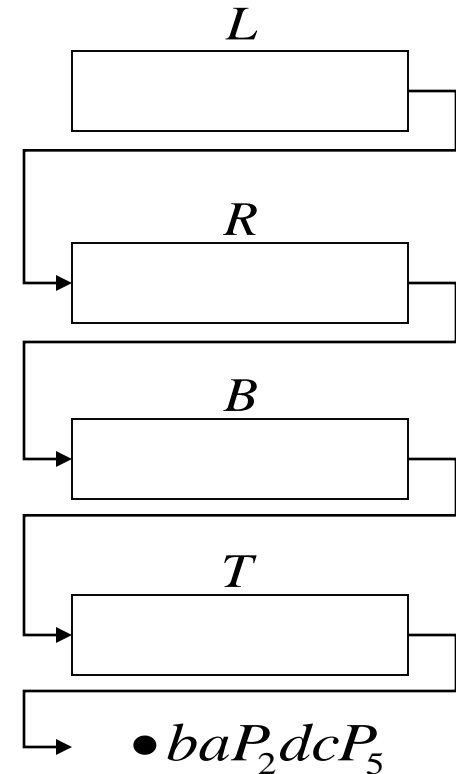
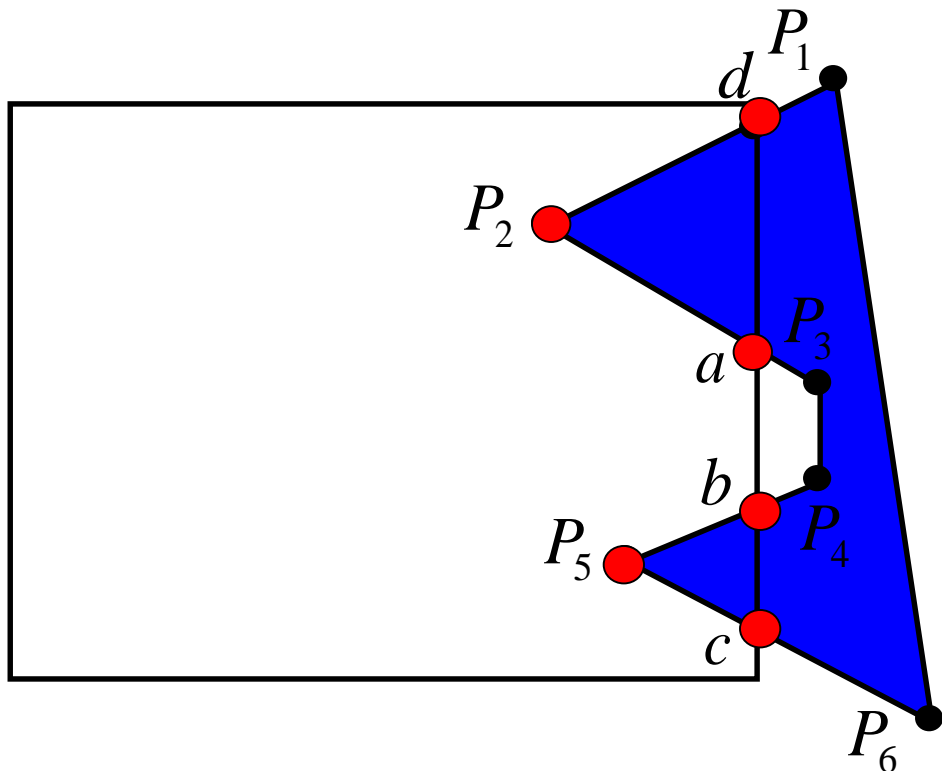
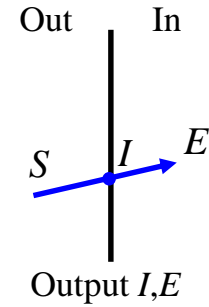
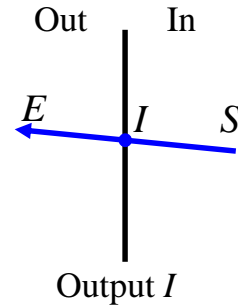
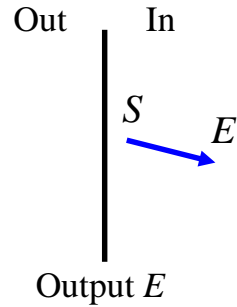
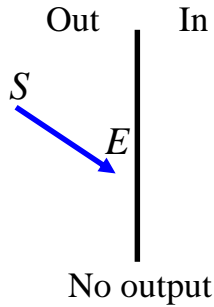

Sutherland-Hodgman Algorithm

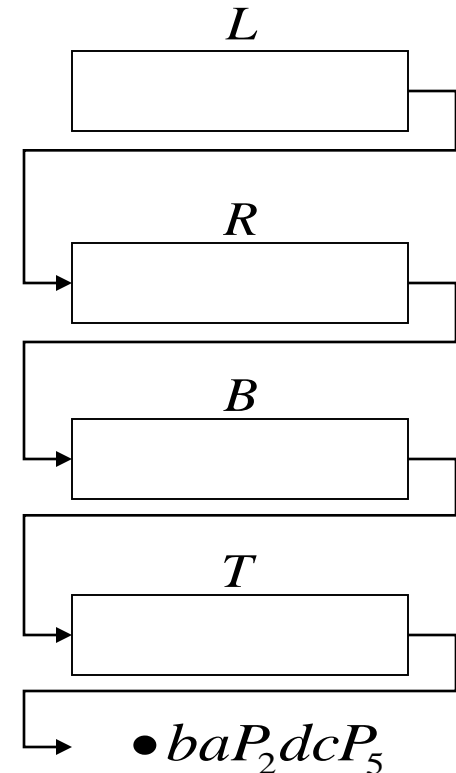
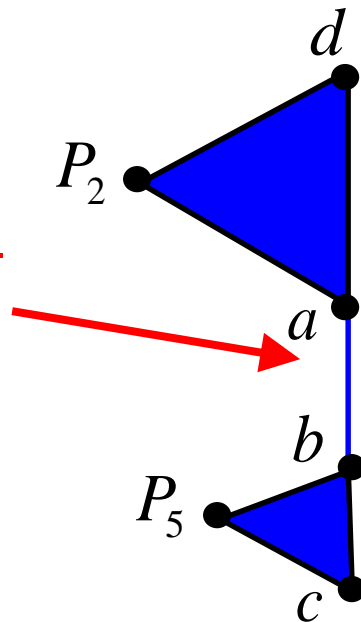
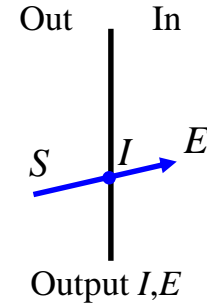
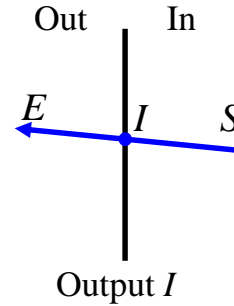
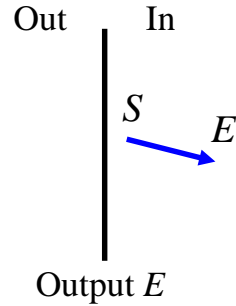
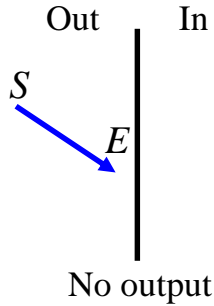

Possible error for non-convex polygons

Sutherland-Hodgman Algorithm

- Easy to pipeline for parallel processing
- Polygon from one boundary does not have to be complete before next boundary starts
- Leads to substantial performance gains

Weiler-Atherton Algorithm

- General polygon vs. polygon clipping
- Handles non-convex shapes

- Not as efficient as Sutherland-Hodgman
- Not easy to parallelize

Weiler-Atherton Algorithm

- Process the edges of the polygon in a counterclockwise order until an inside-outside pair of vertices is encountered
- Follow the window boundaries in a counterclockwise direction from the exit-intersection point to another intersection point with the polygon
- Repeat until at a previously processed vertex
- Return to the exit-intersection point and continue processing the polygon edges in a counterclockwise order

Weiler-Atherton Algorithm

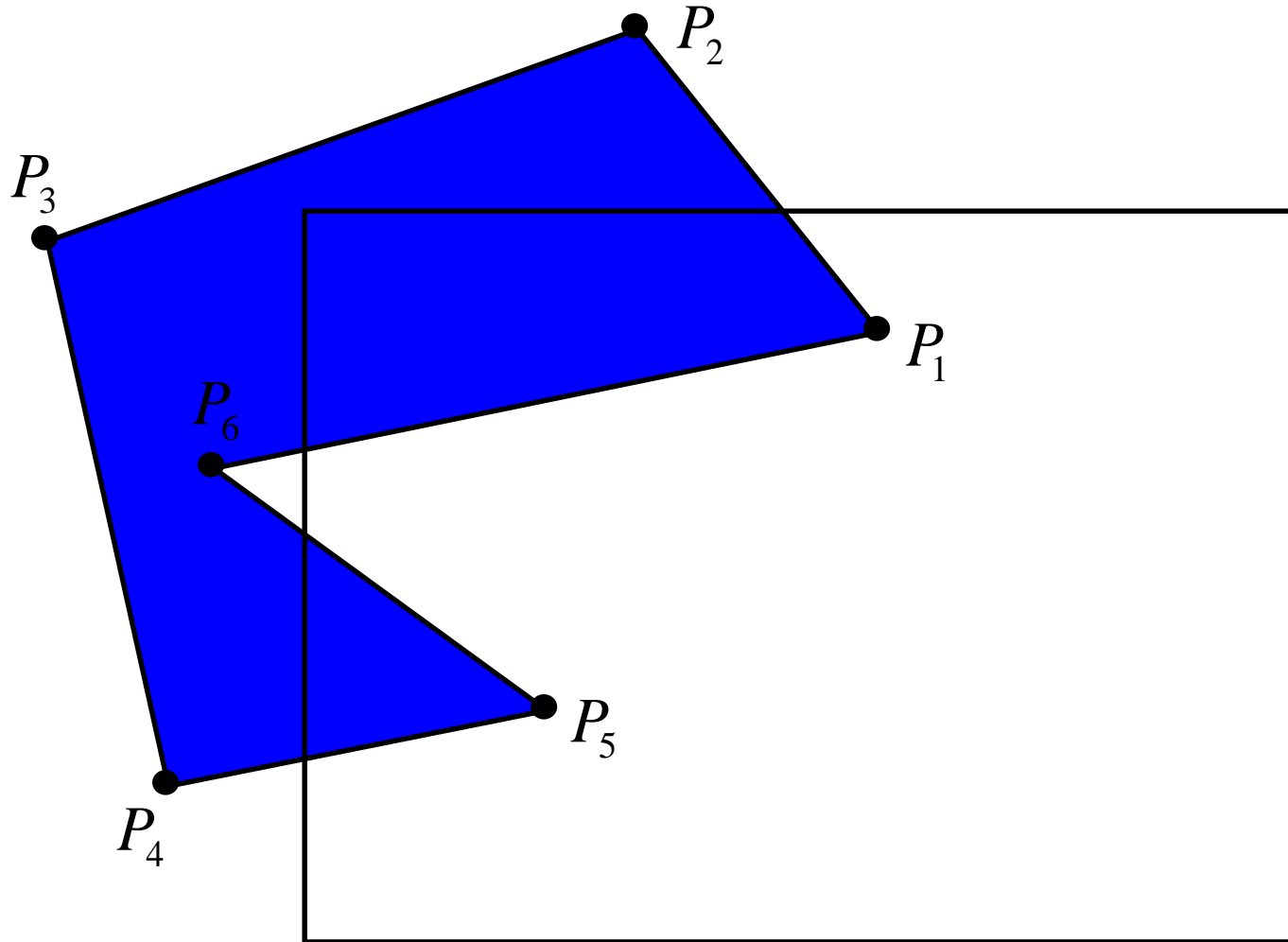

Weiler-Atherton Algorithm

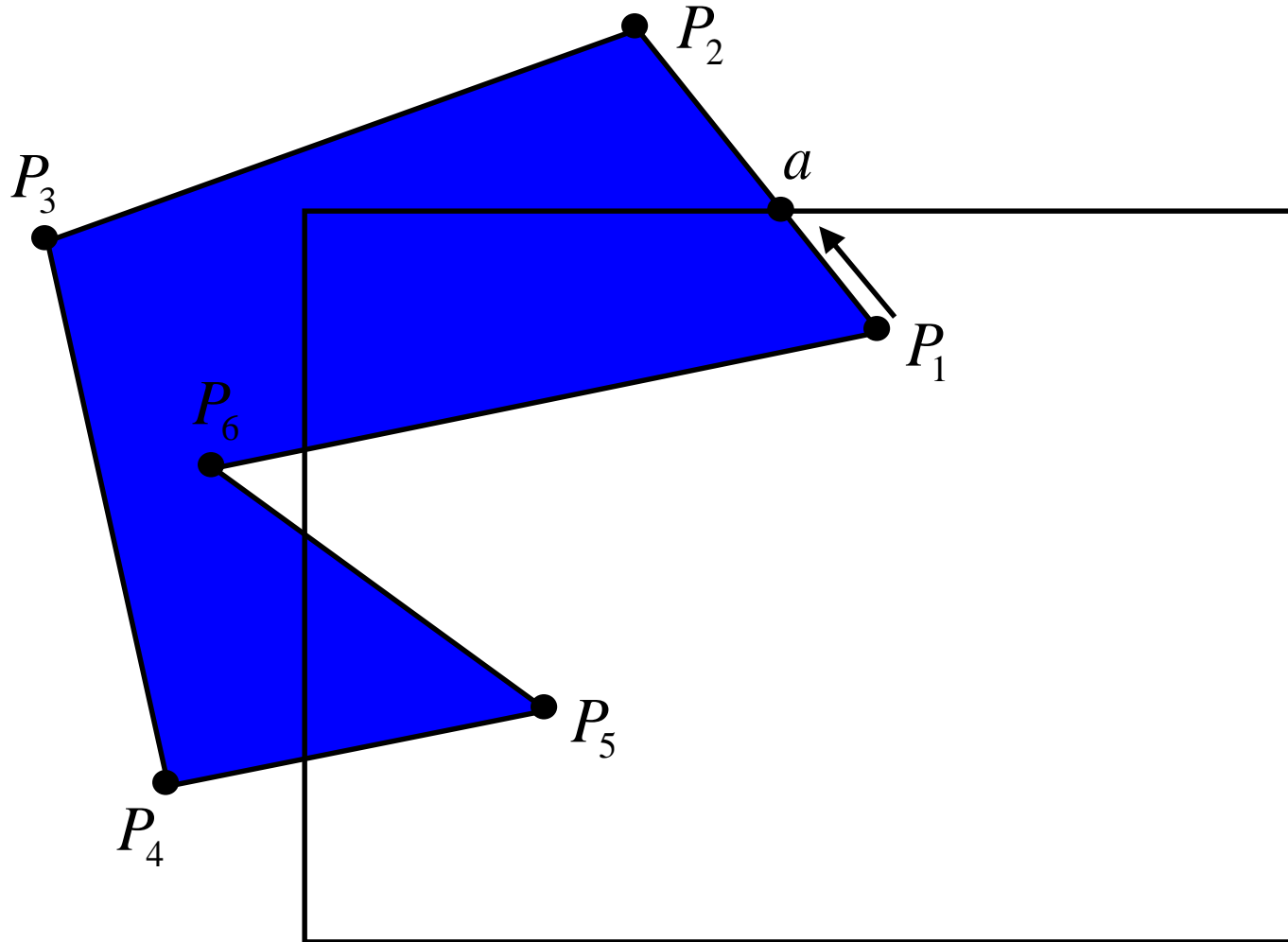

Weiler-Atherton Algorithm

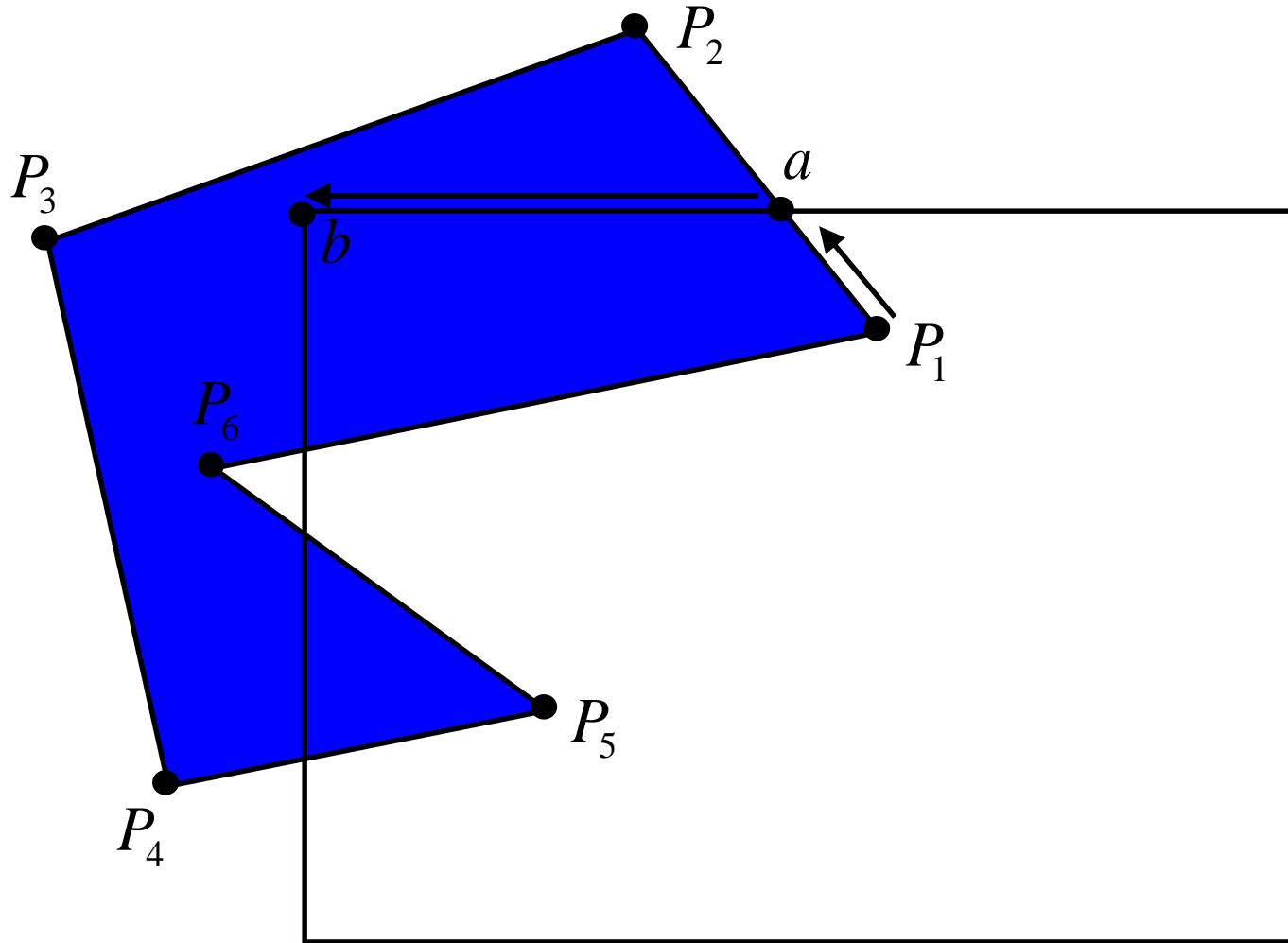

Weiler-Atherton Algorithm

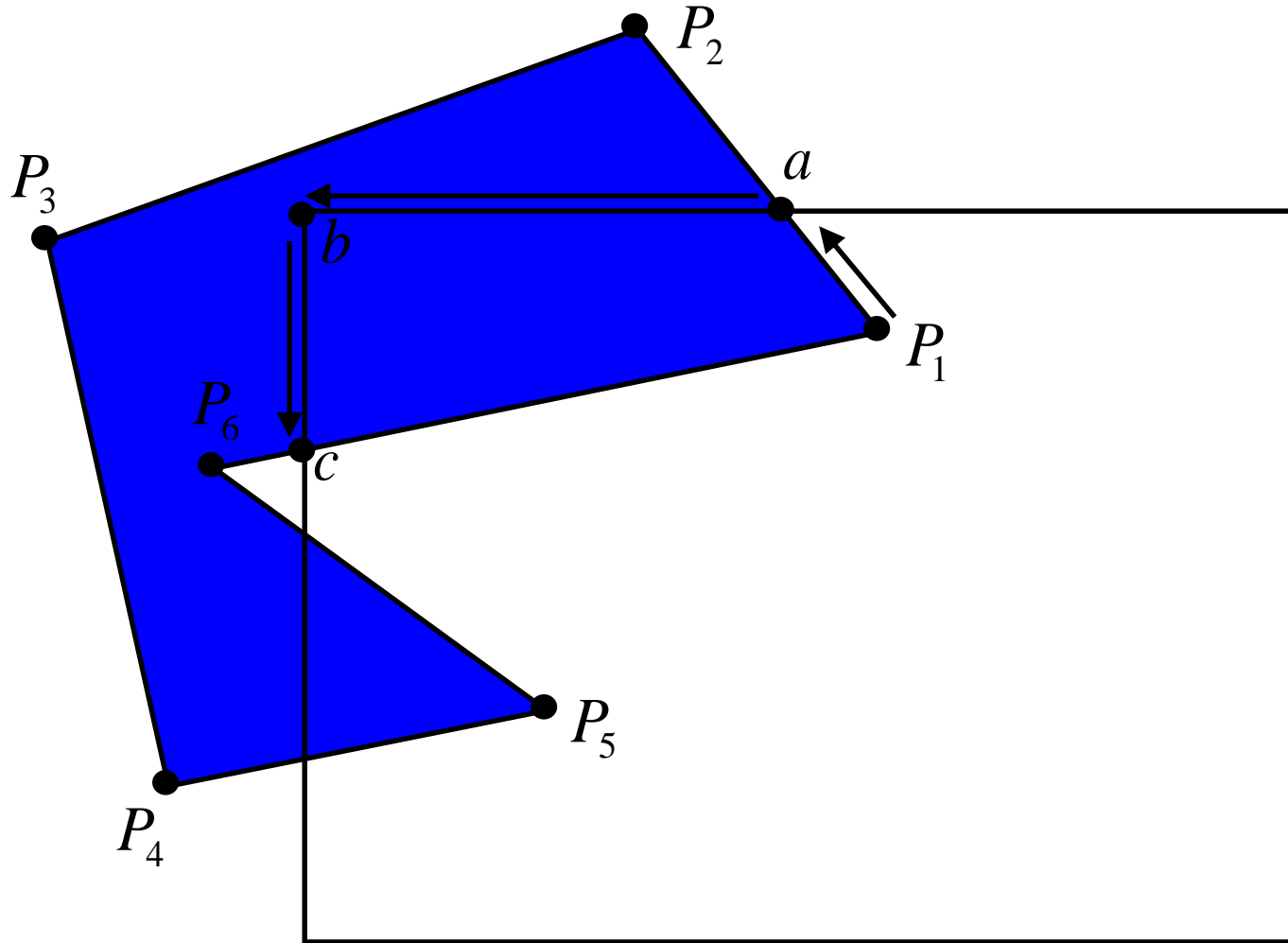

Weiler-Atherton Algorithm

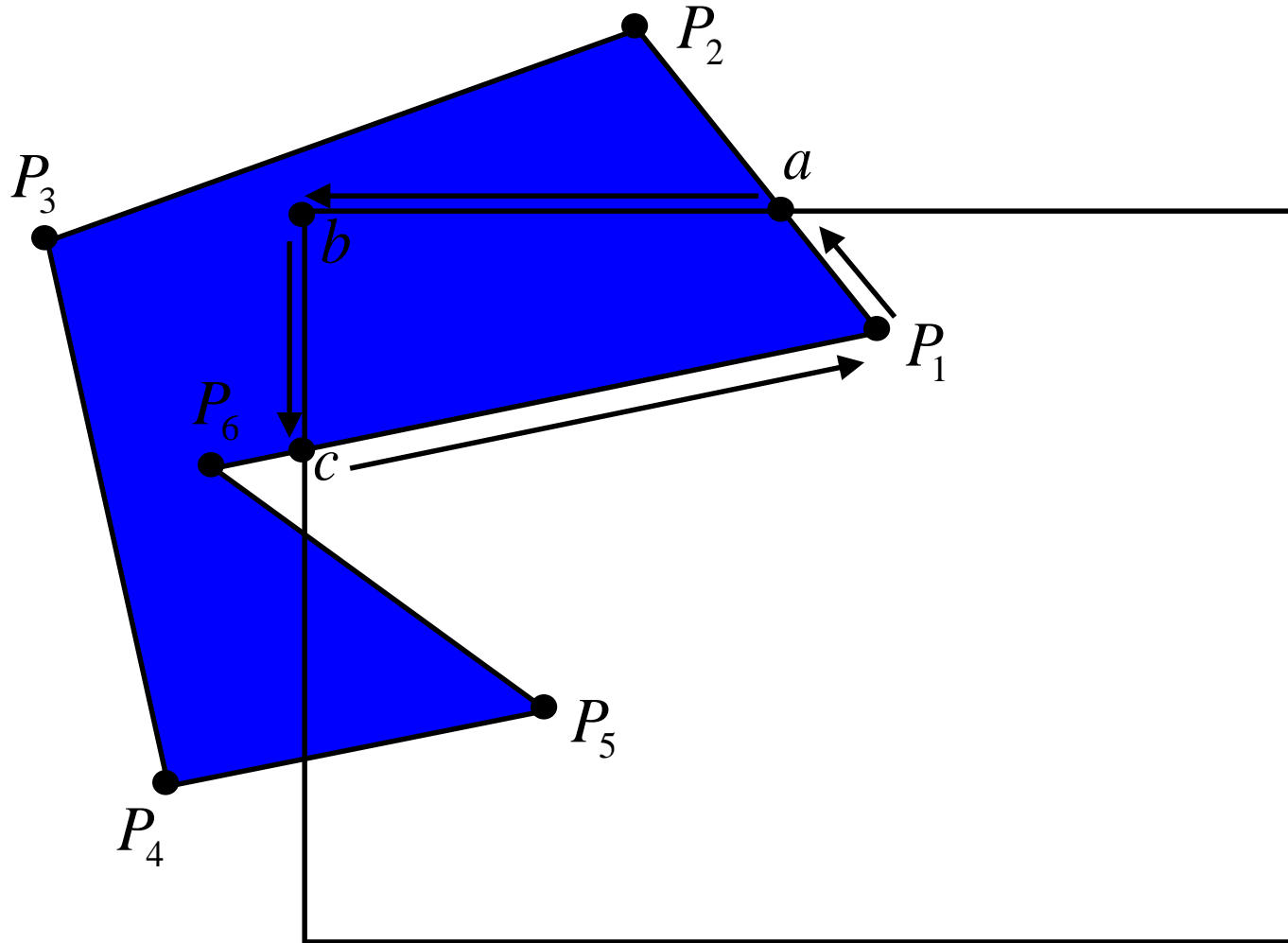

Weiler-Atherton Algorithm

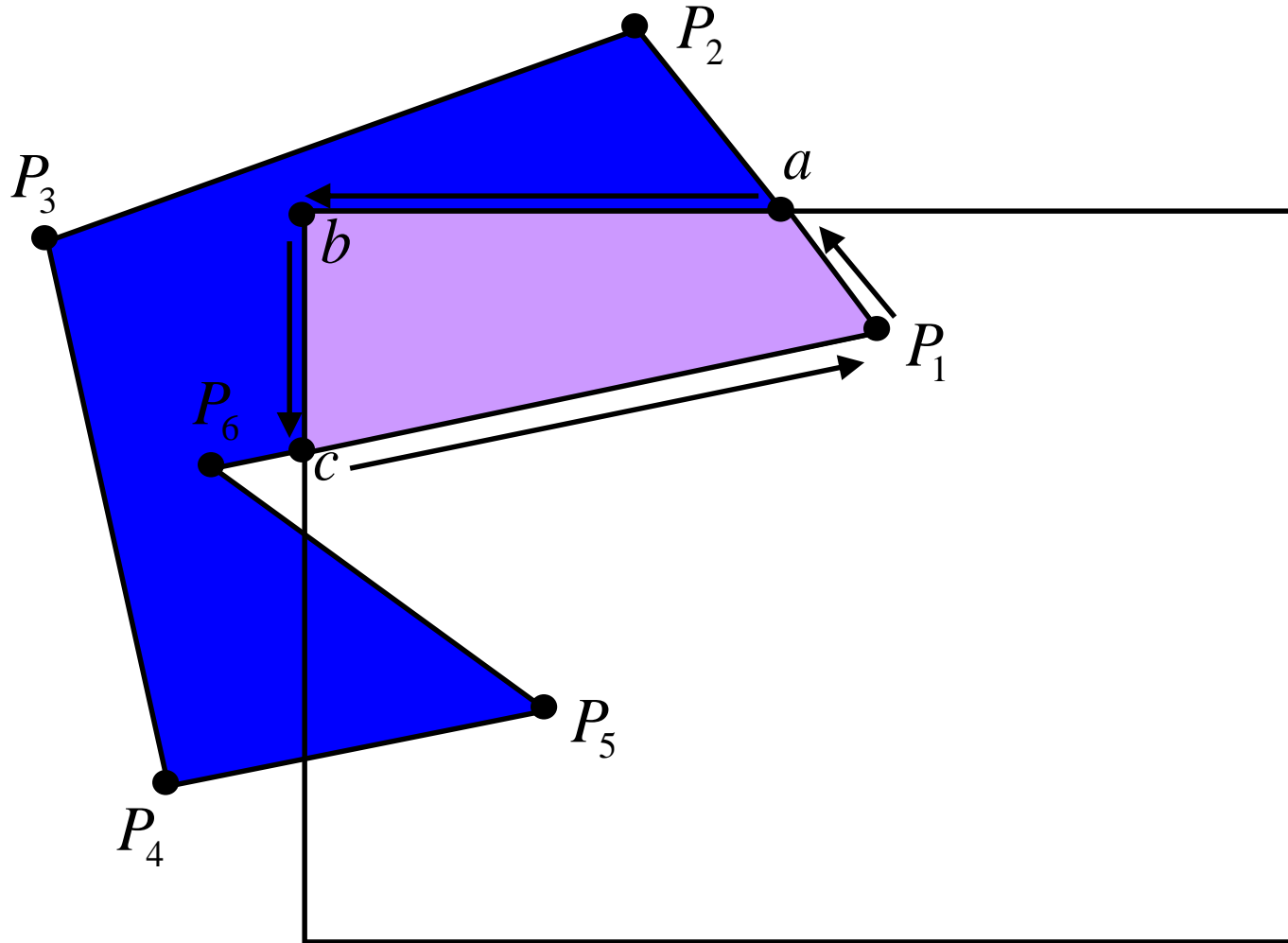

Weiler-Atherton Algorithm

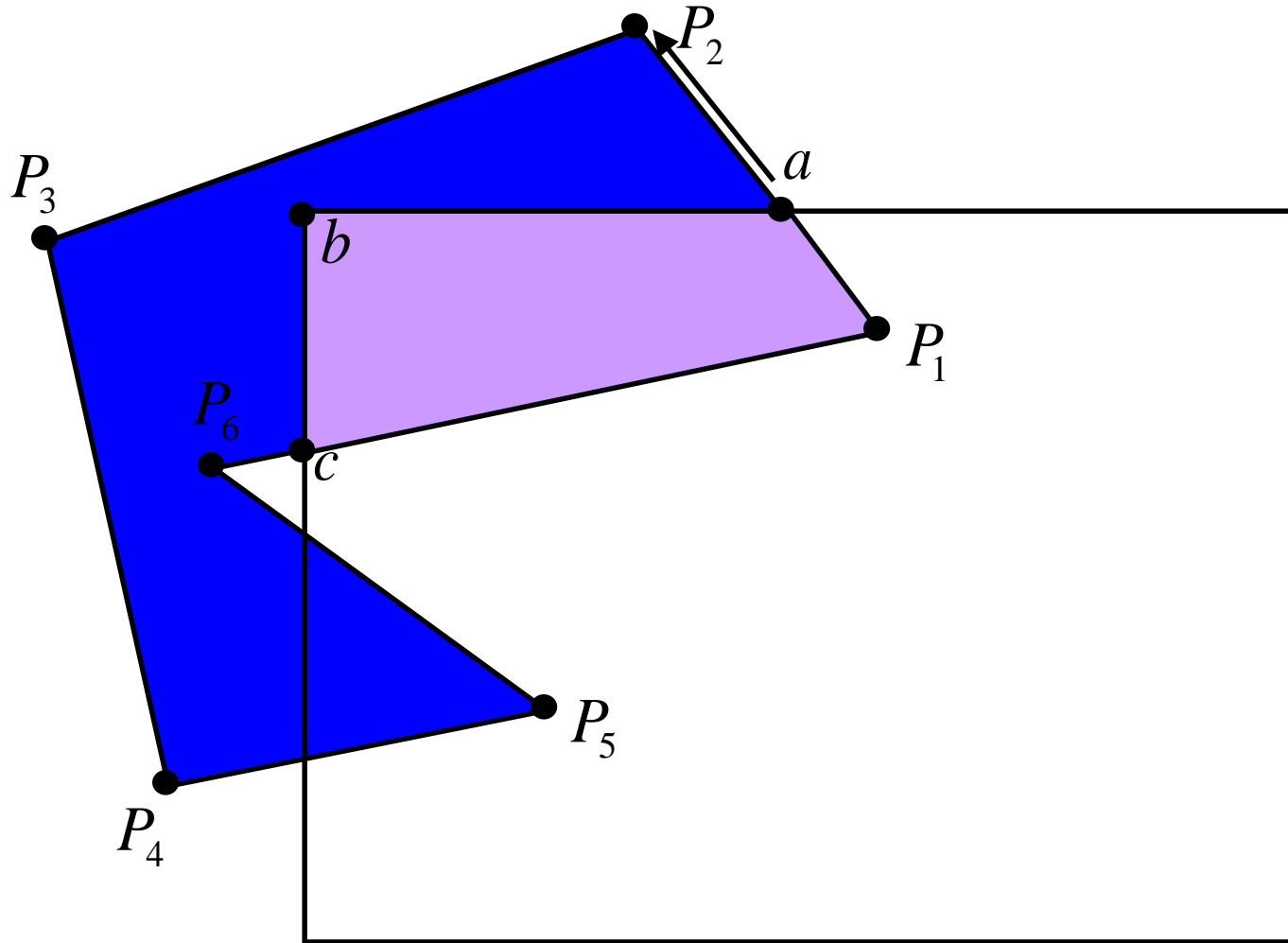

Weiler-Atherton Algorithm

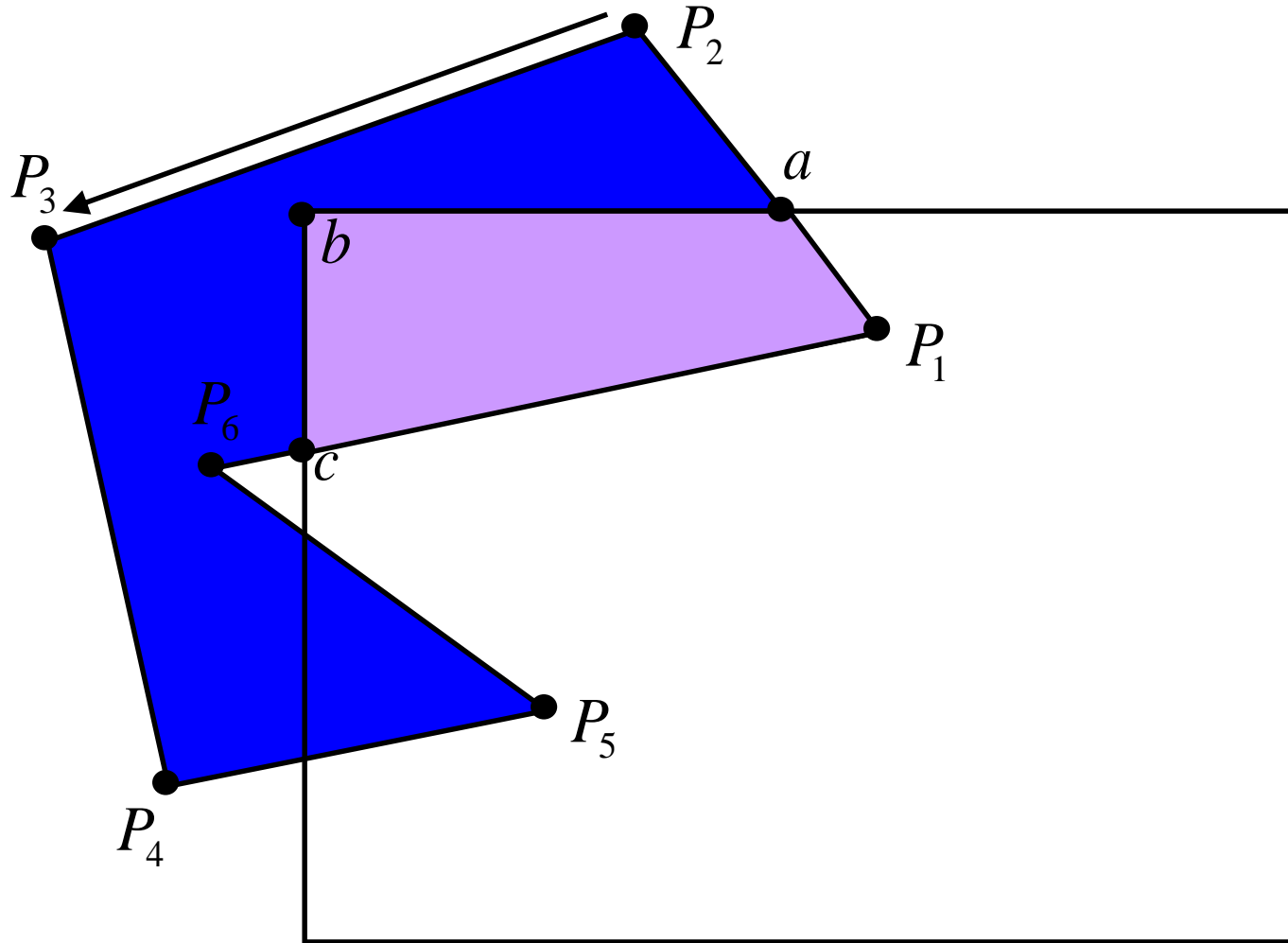

Weiler-Atherton Algorithm

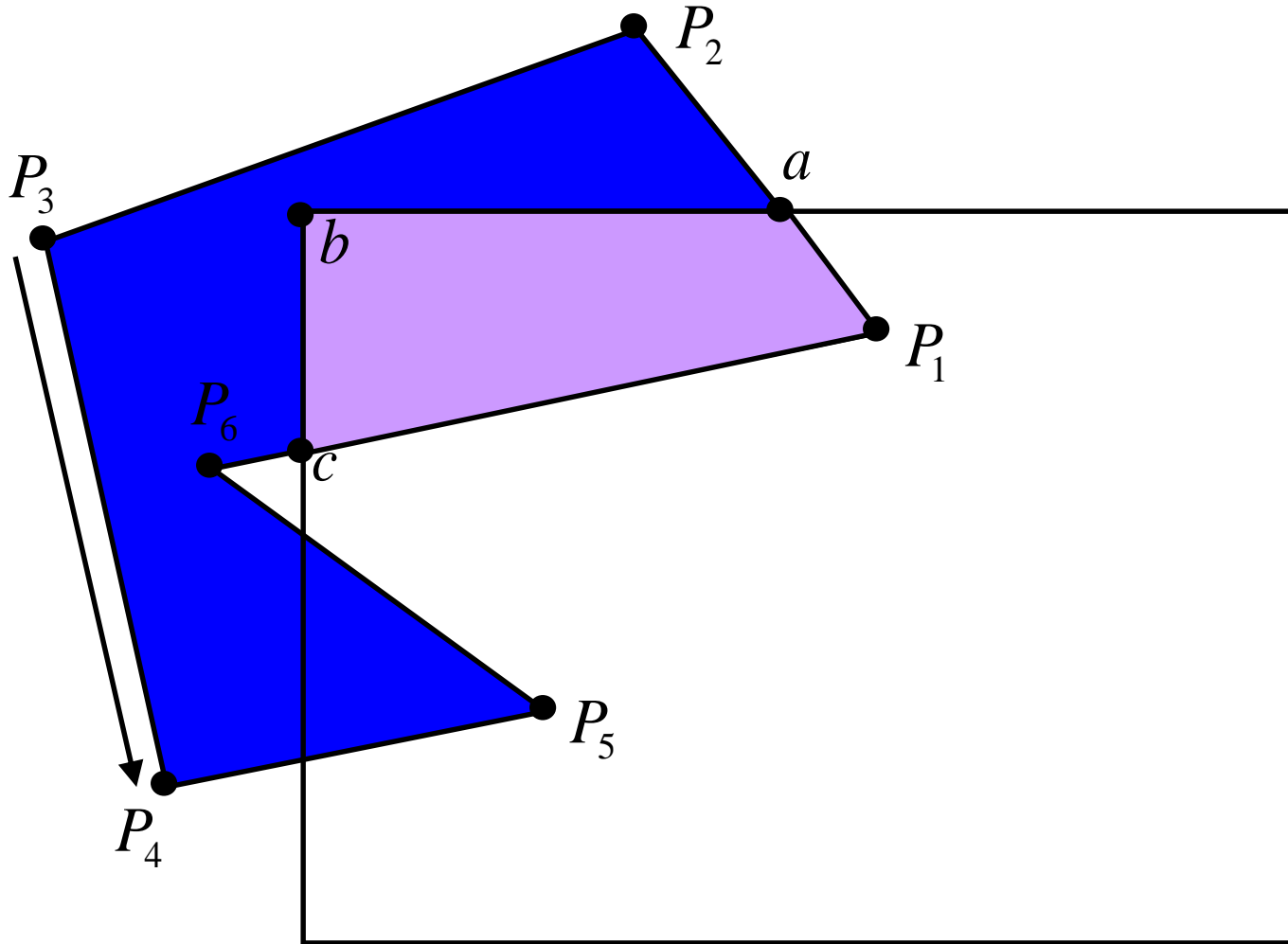

Weiler-Atherton Algorithm

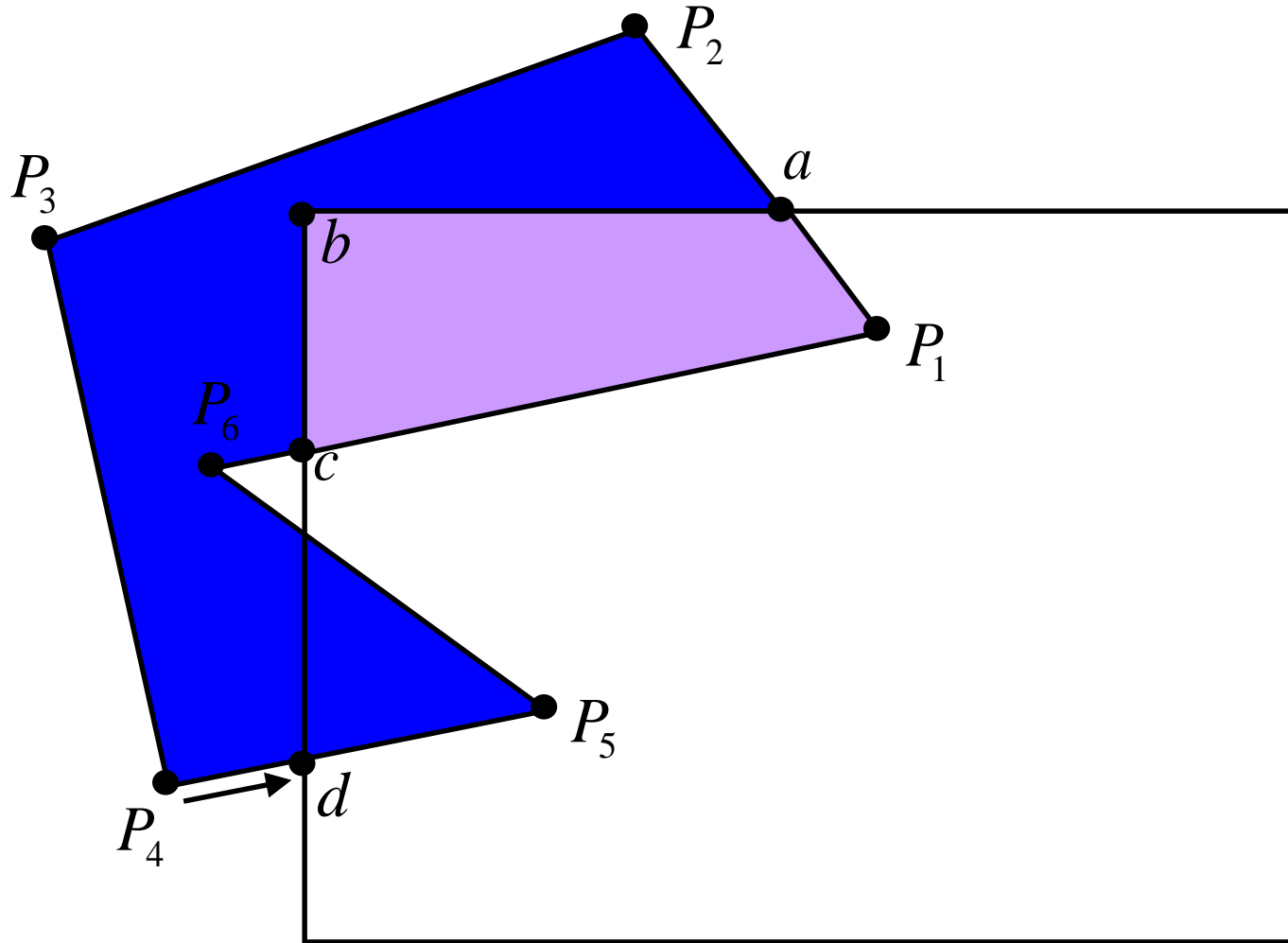

Weiler-Atherton Algorithm

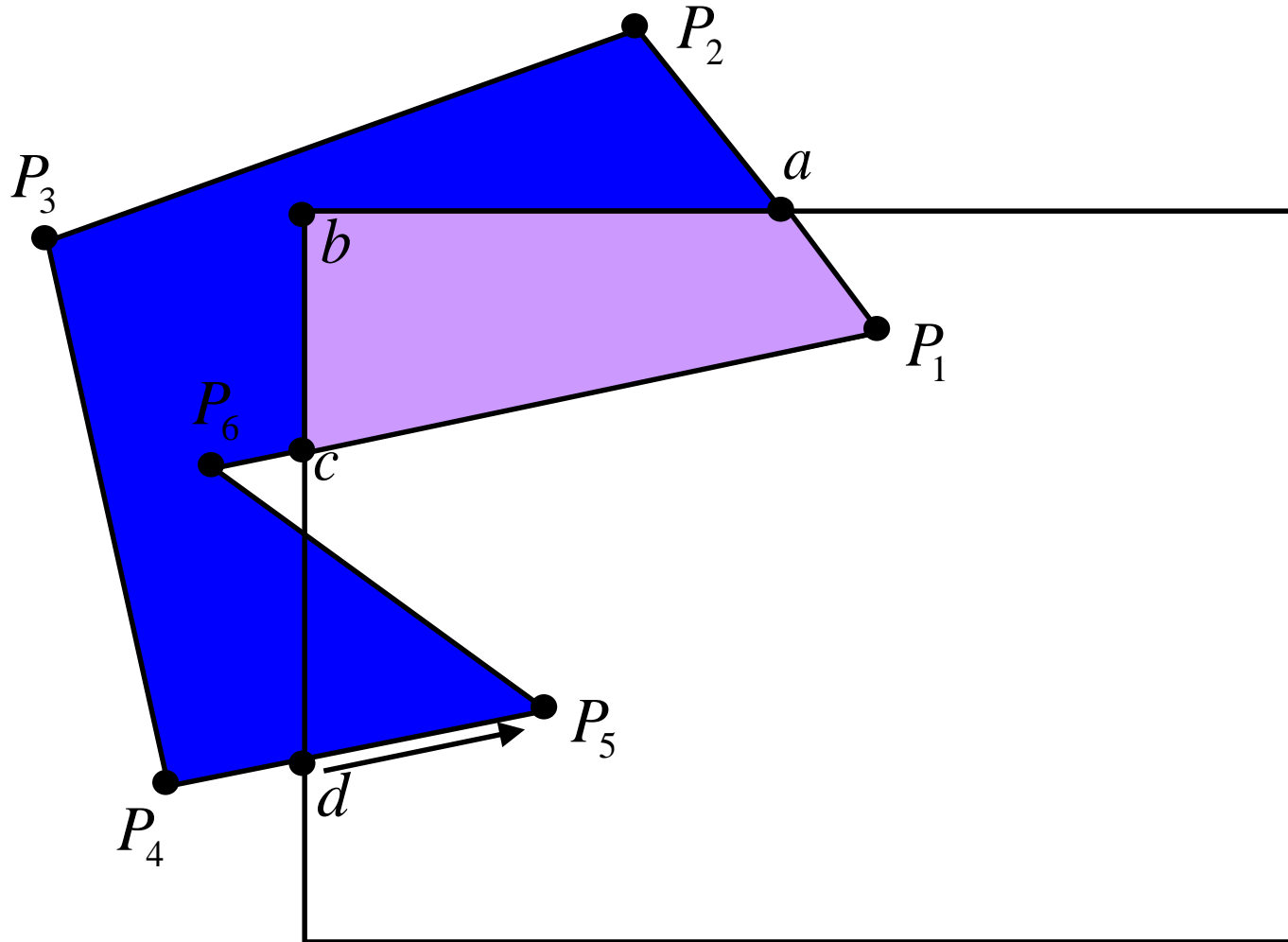

Weiler-Atherton Algorithm

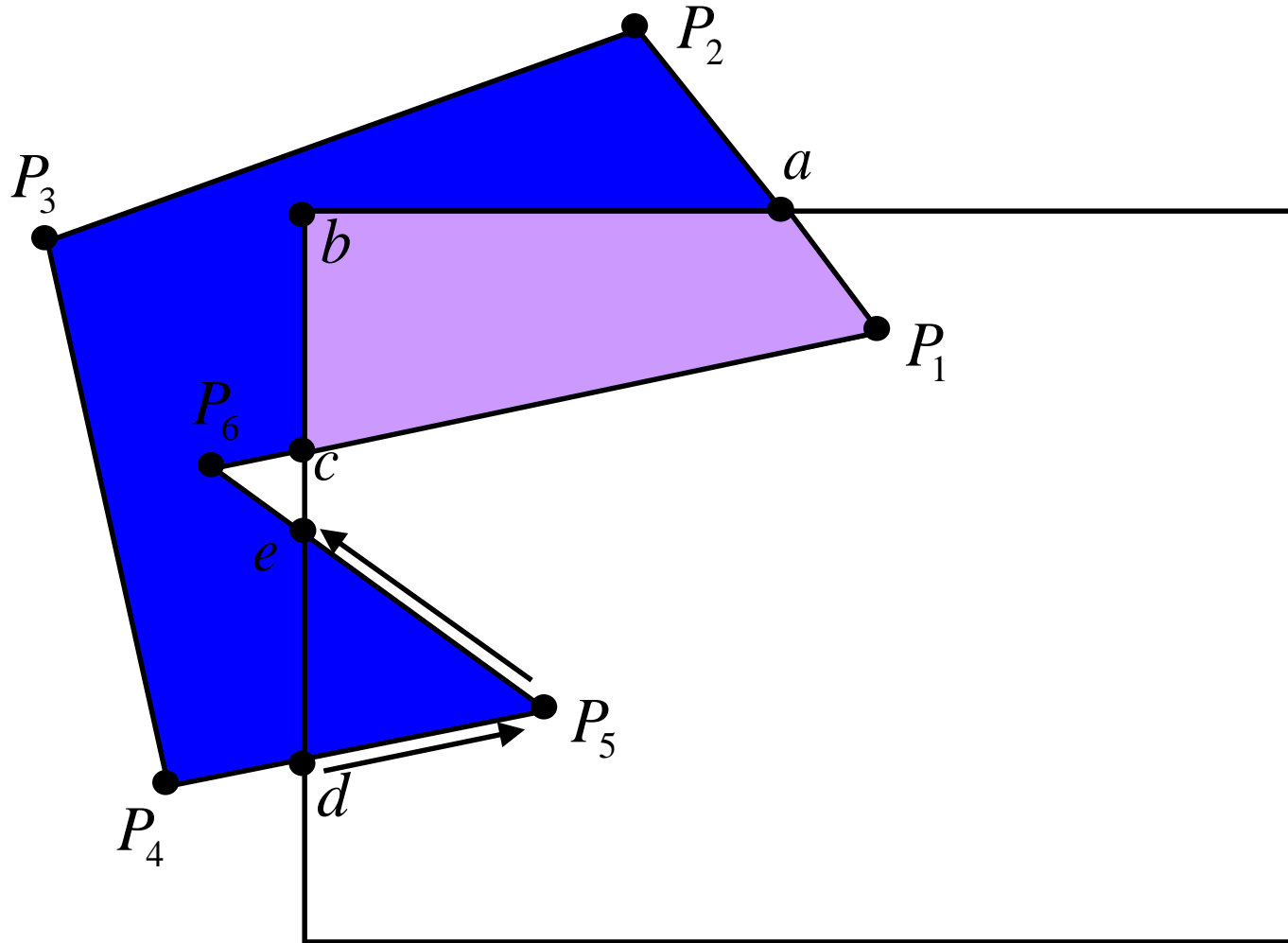

Weiler-Atherton Algorithm

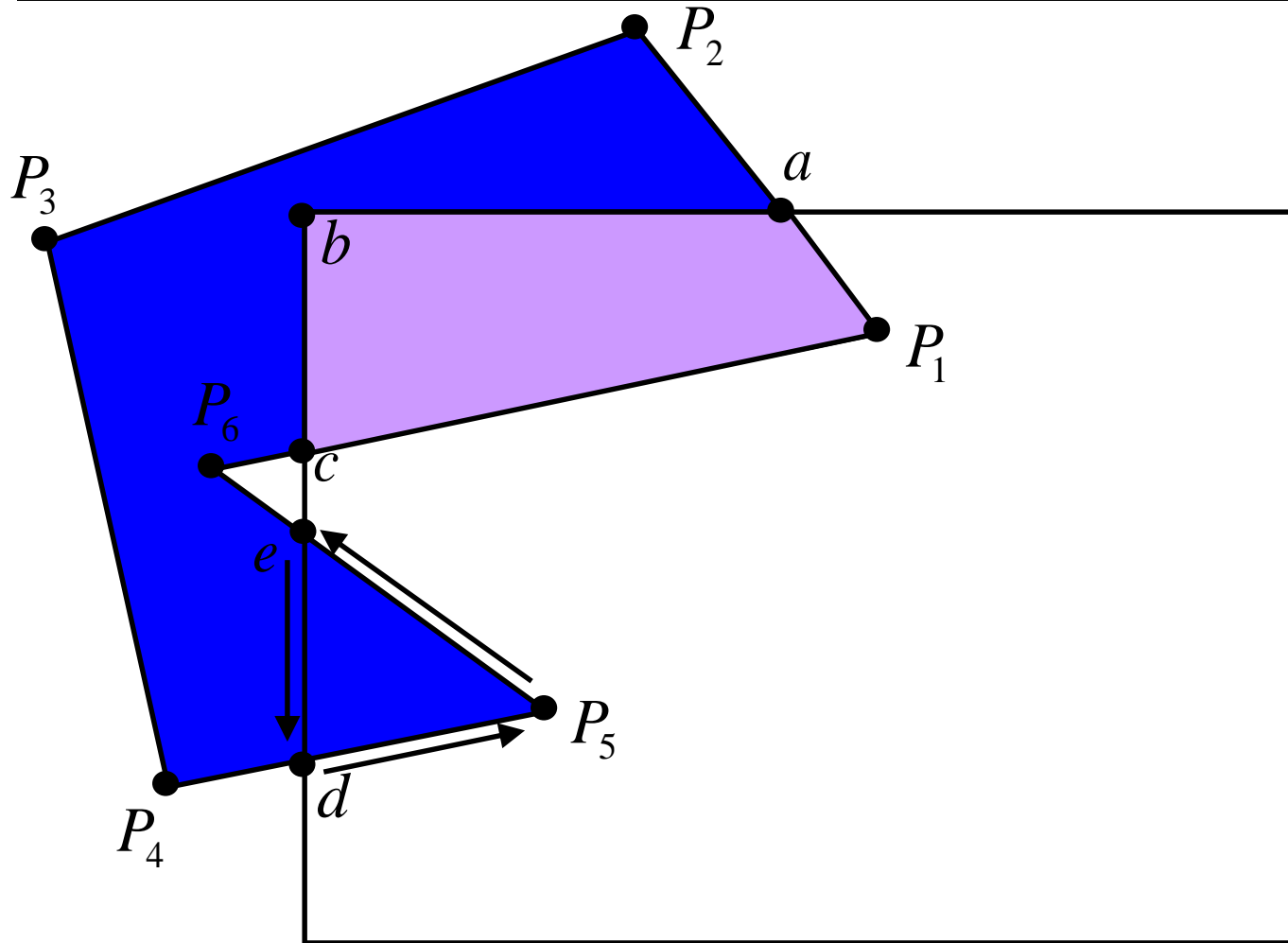

Weiler-Atherton Algorithm

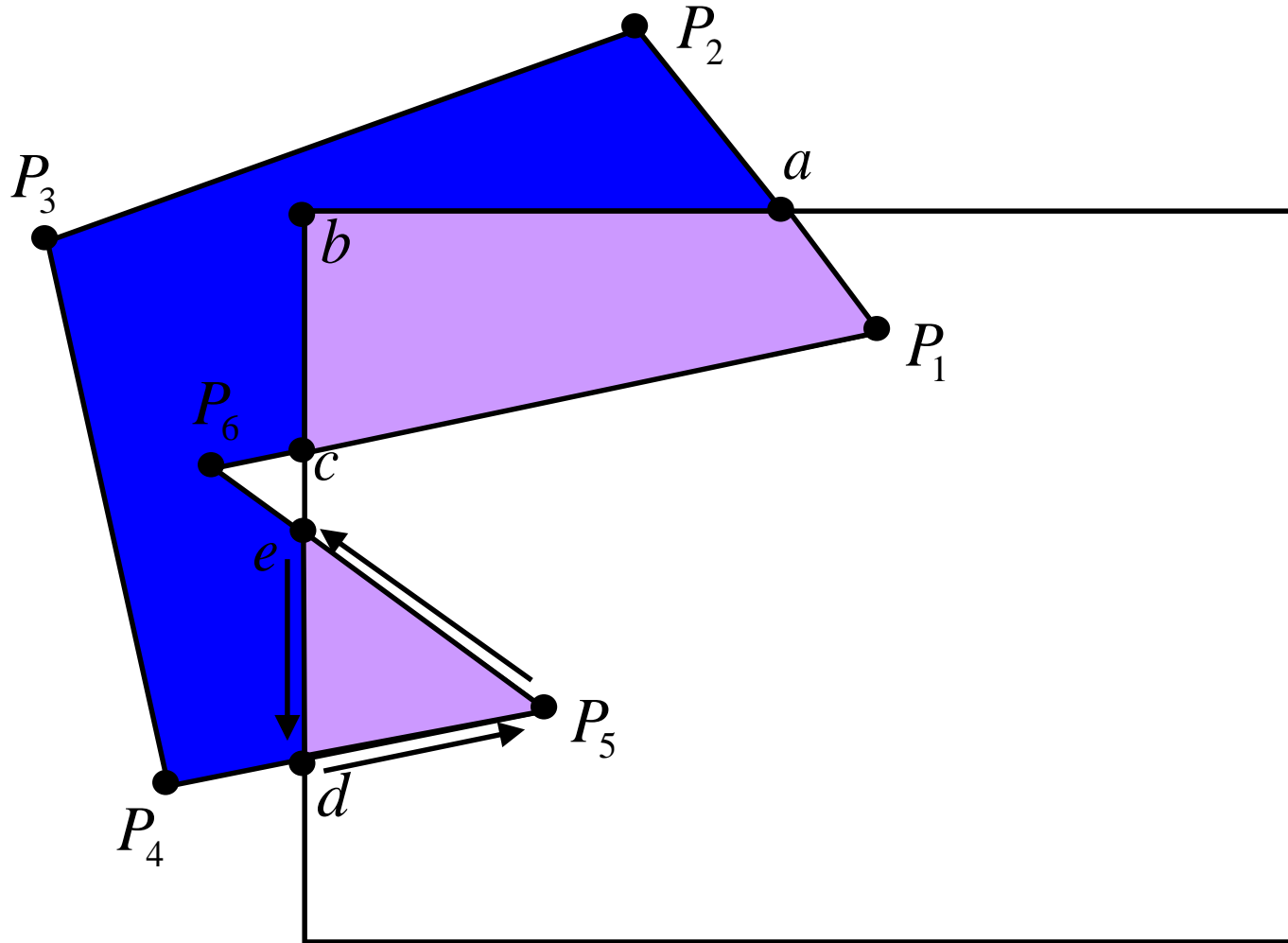

Weiler-Atherton Algorithm

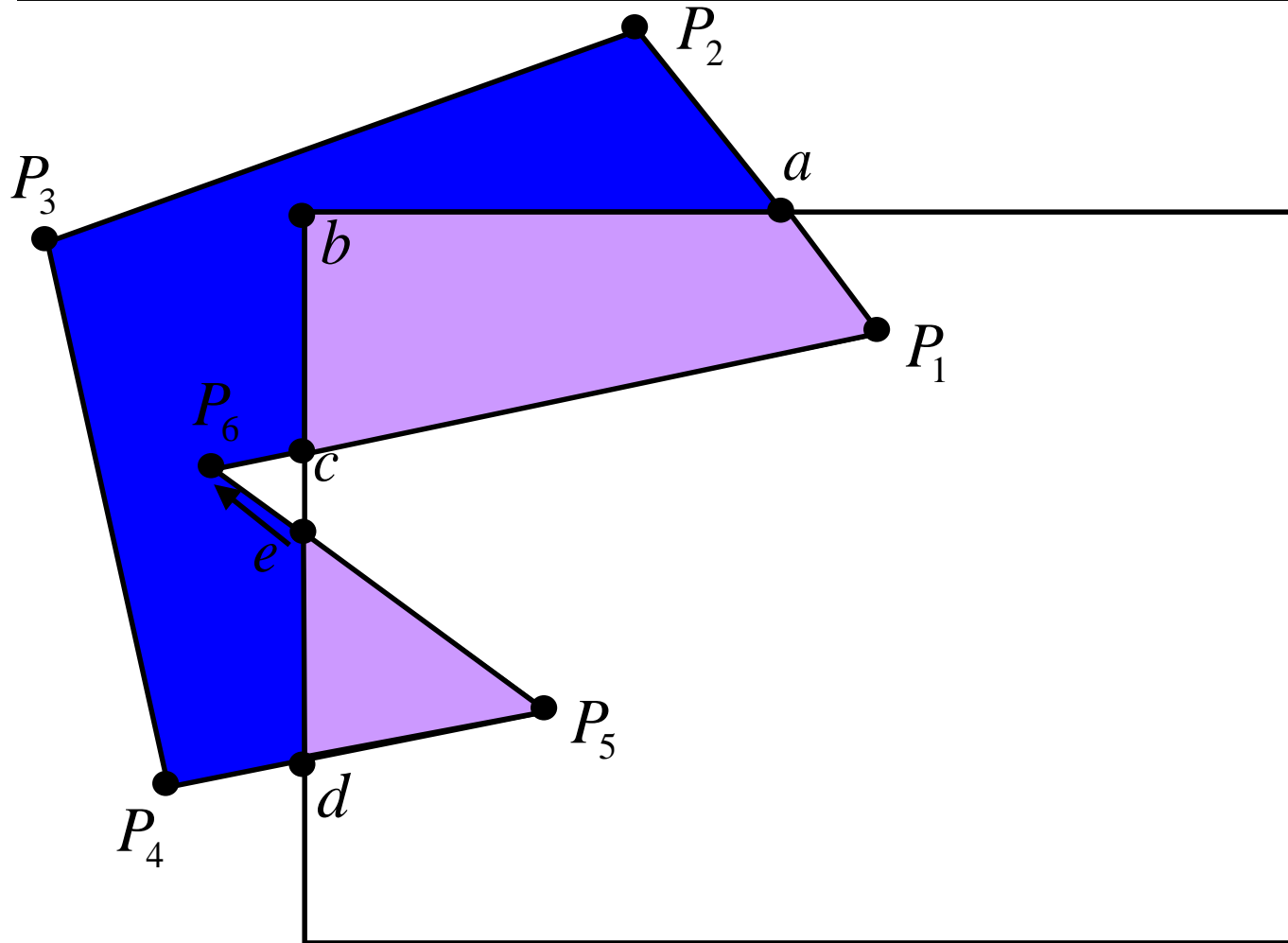

Weiler-Atherton Algorithm

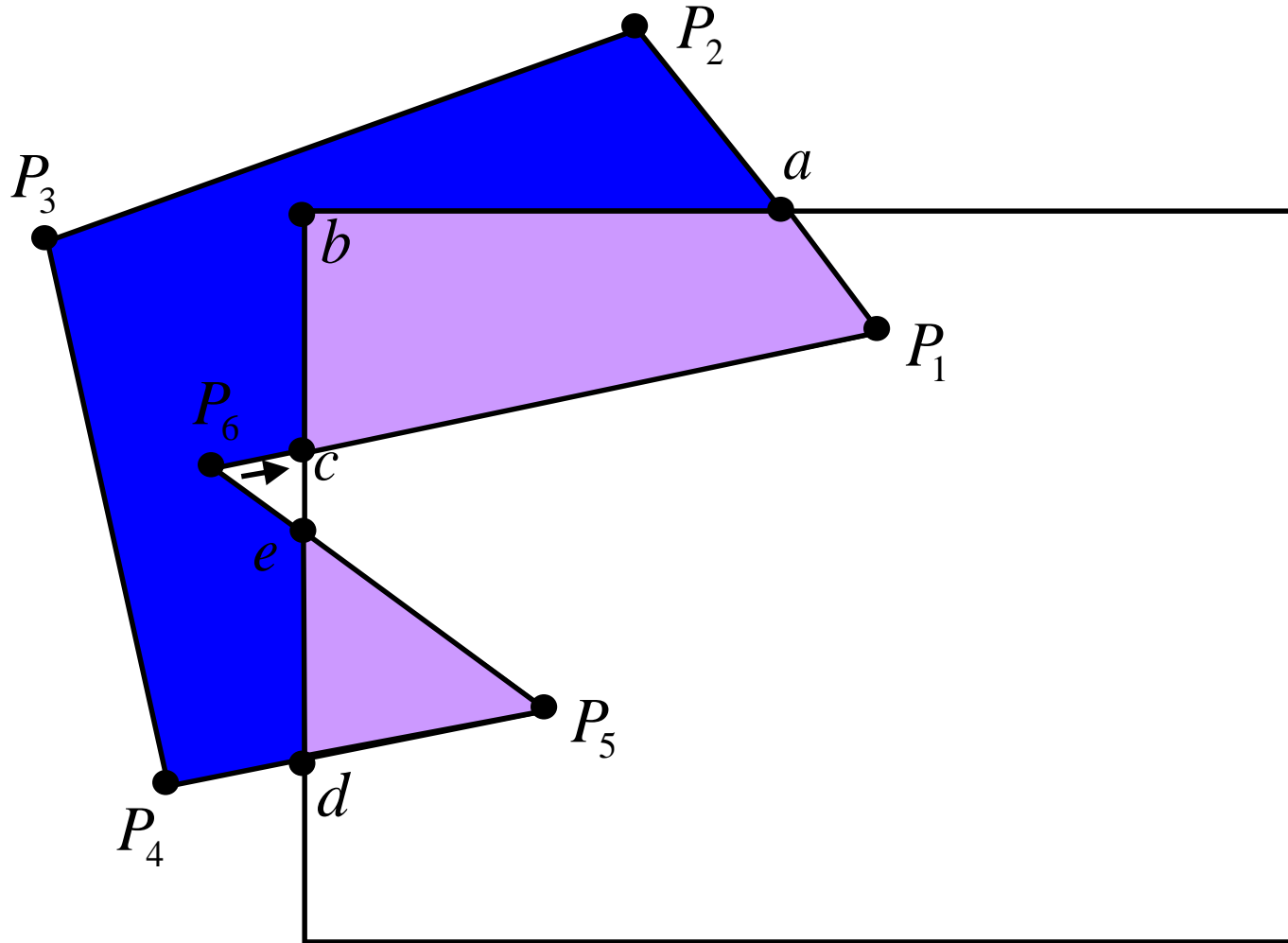

Weiler-Atherton Algorithm

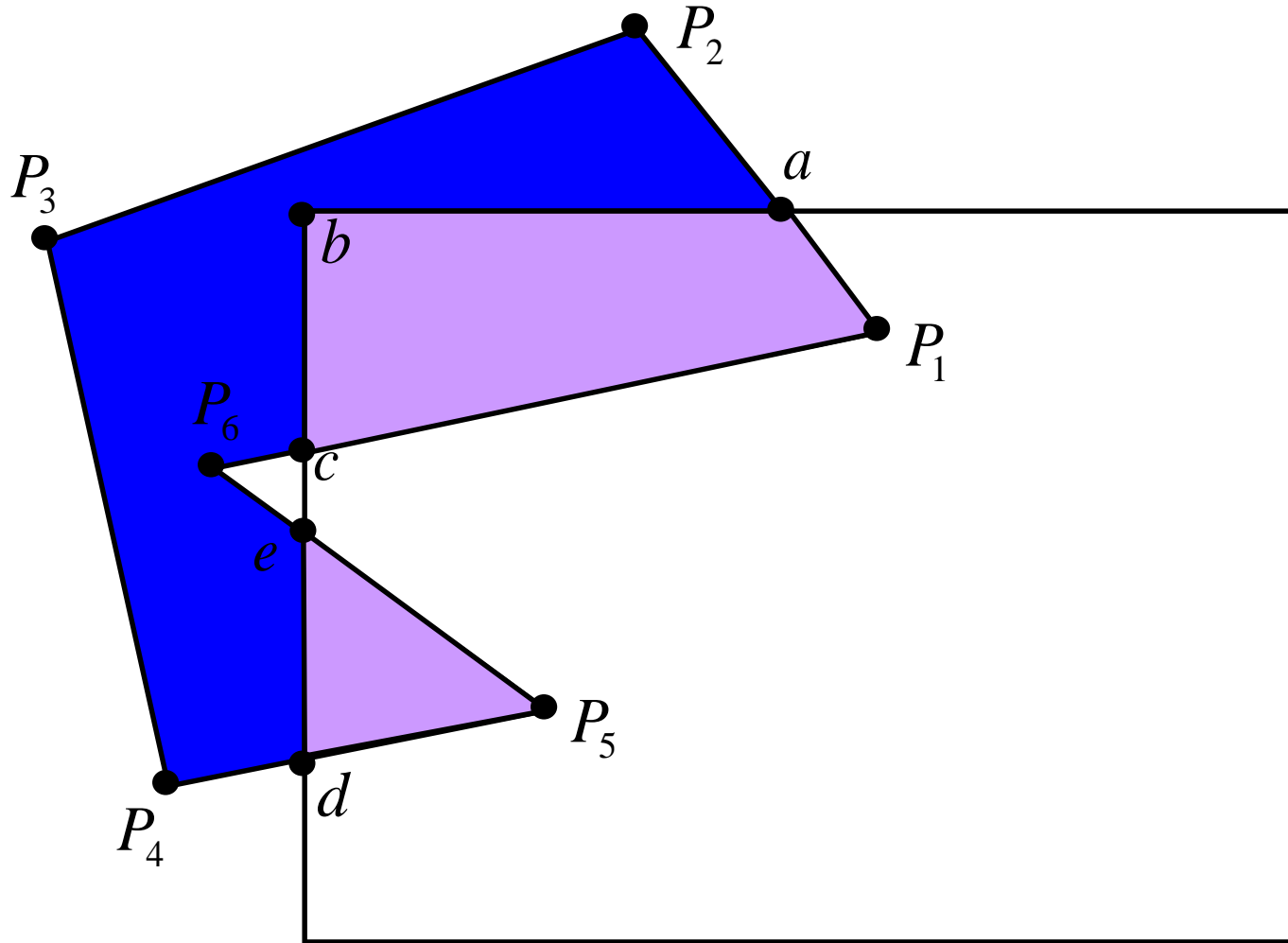

Weiler-Atherton Algorithm

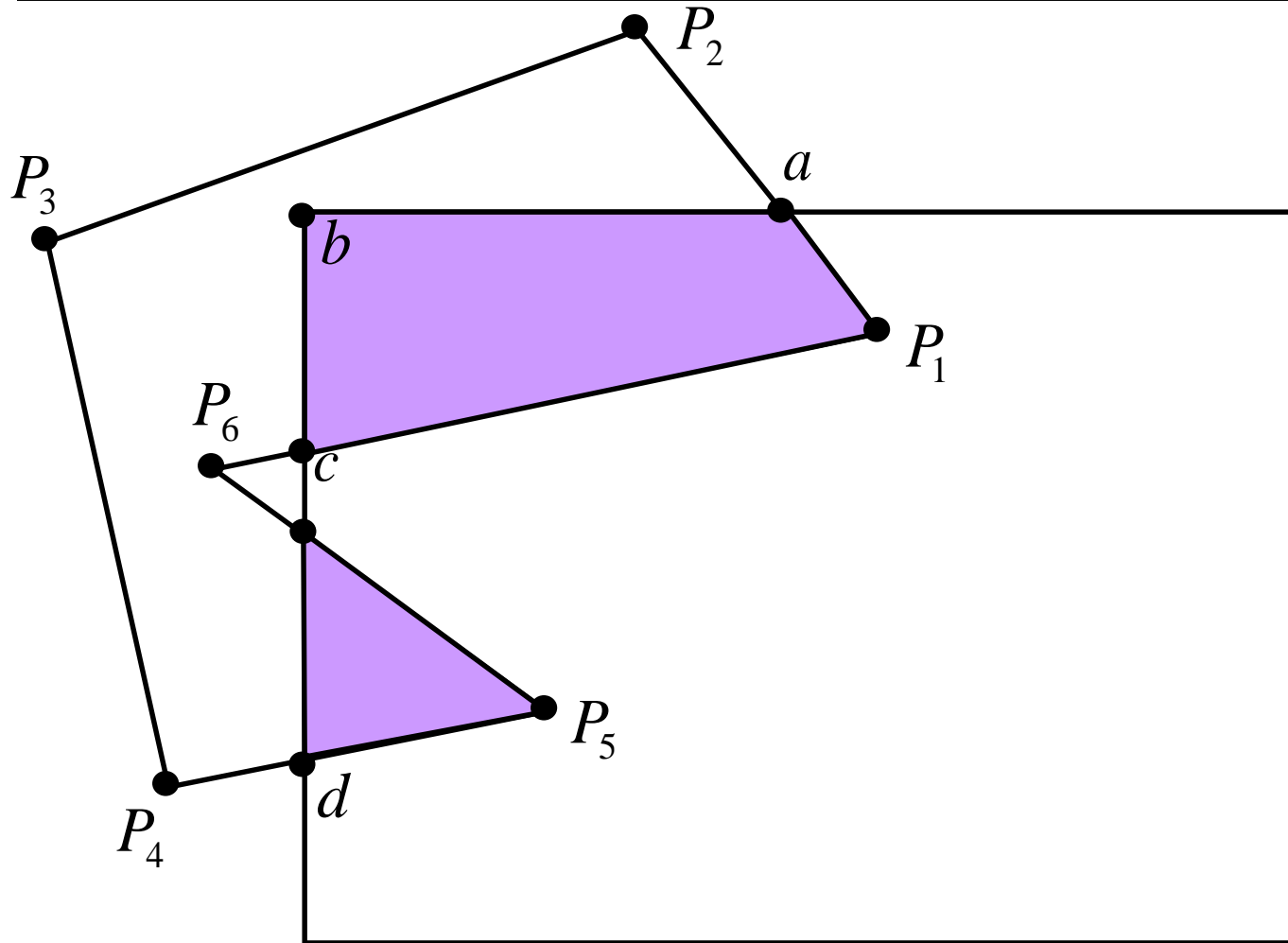



Sutherland-Hodgman Algorithm

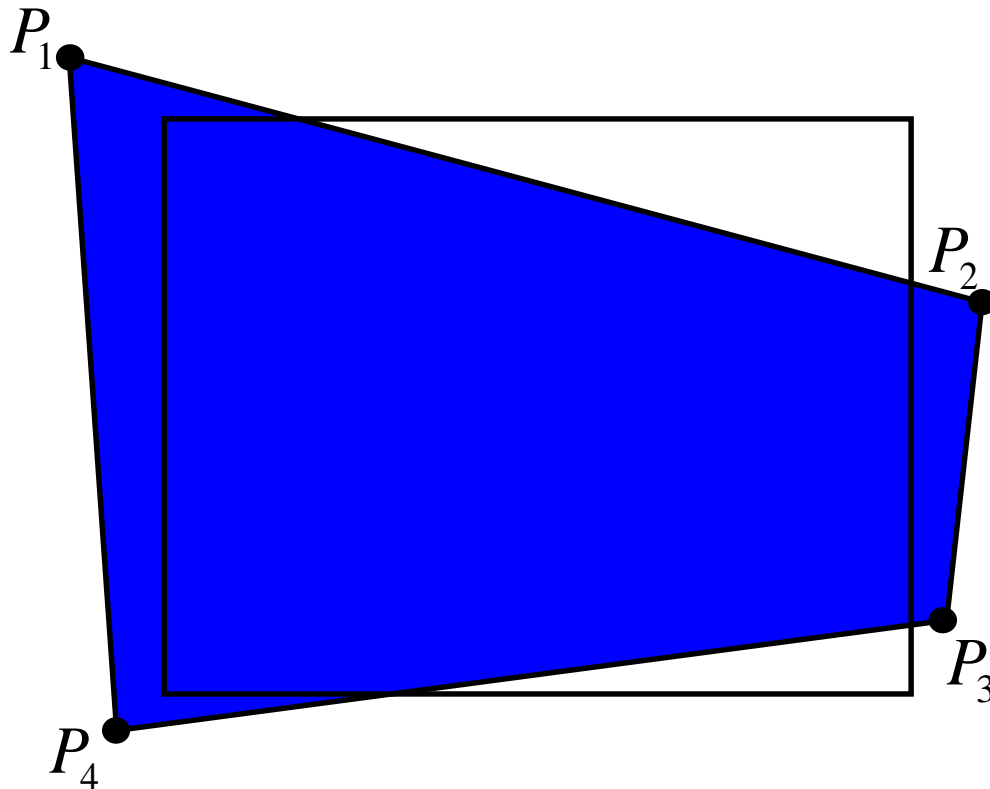
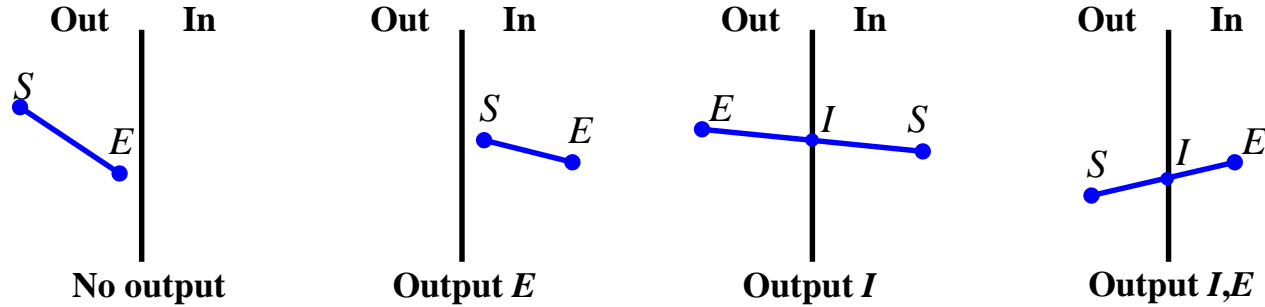

Sutherland-Hodgman Algorithm

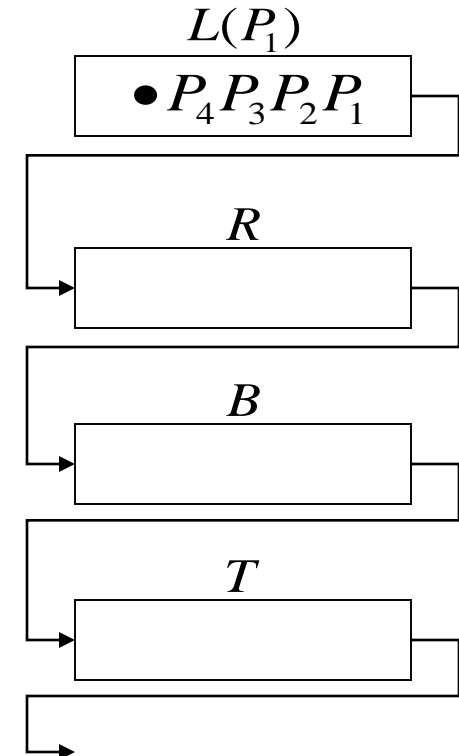
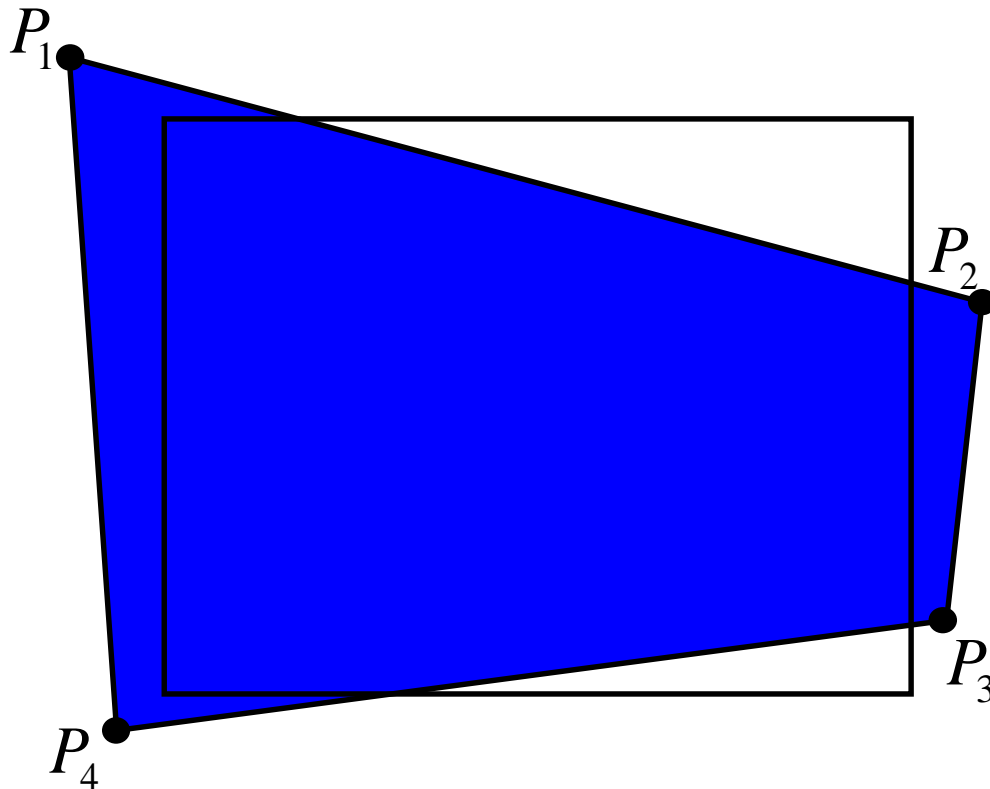
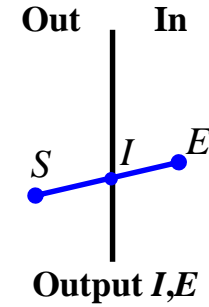
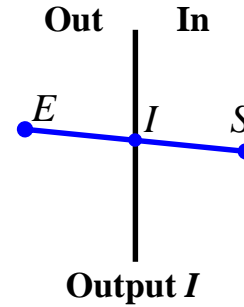
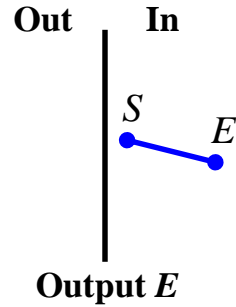
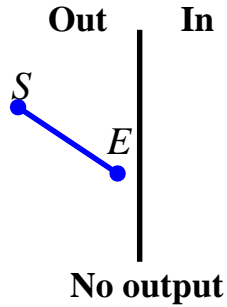

Sutherland-Hodgman Algorithm

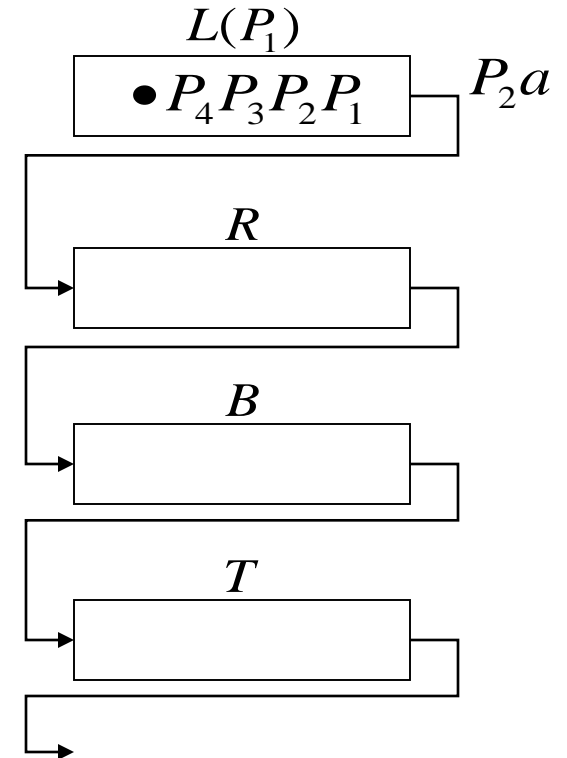
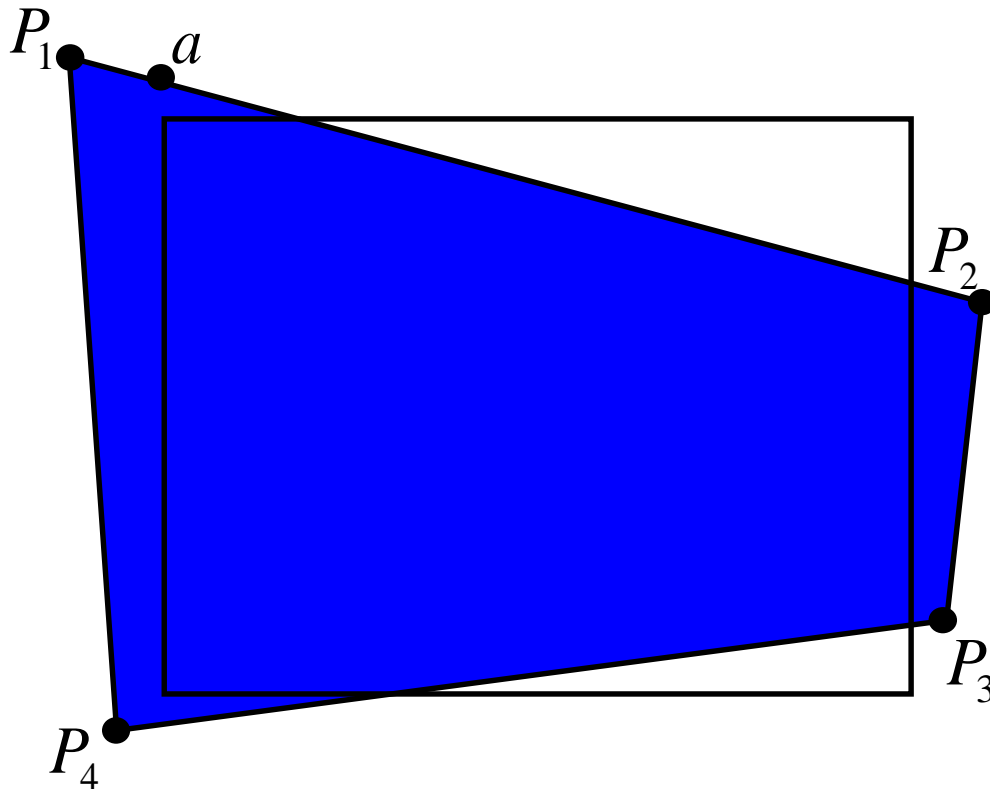
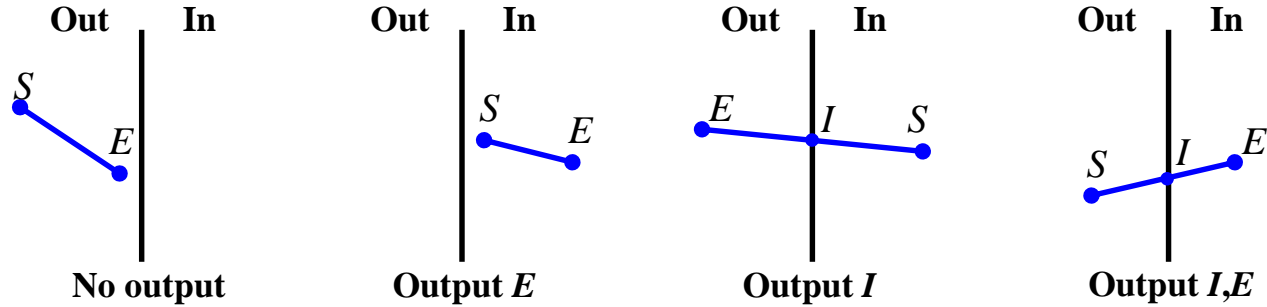

Sutherland-Hodgman Algorithm

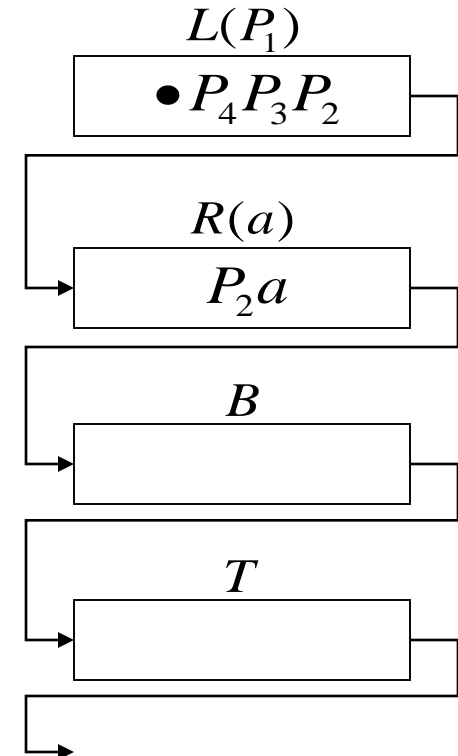
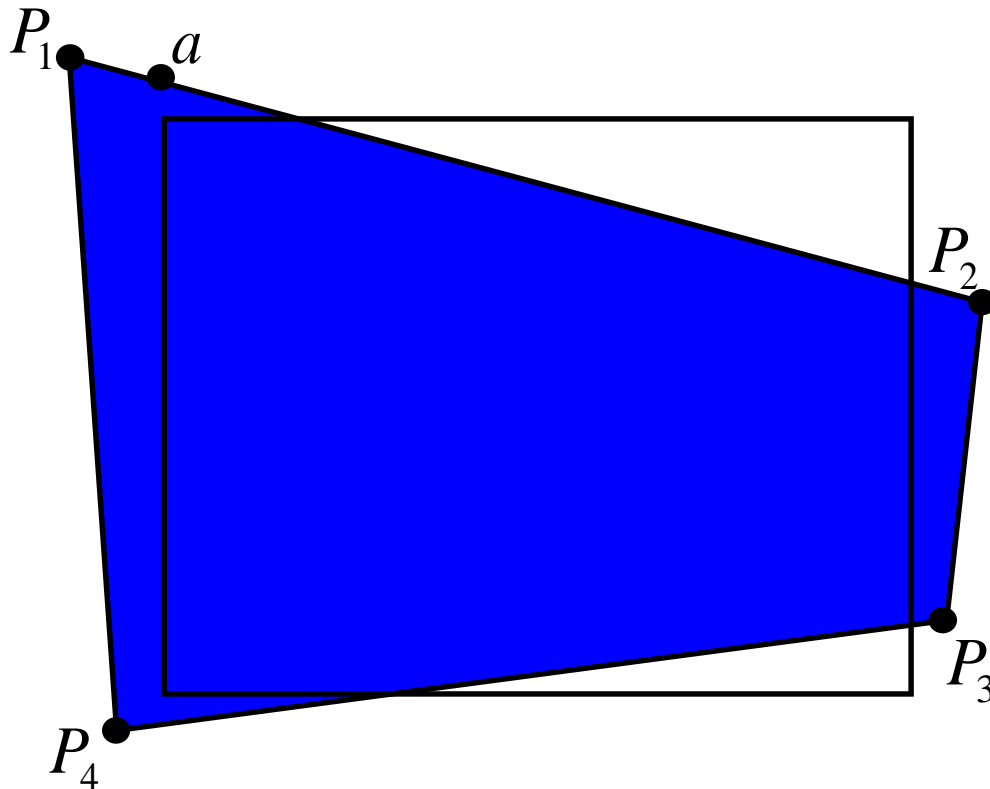
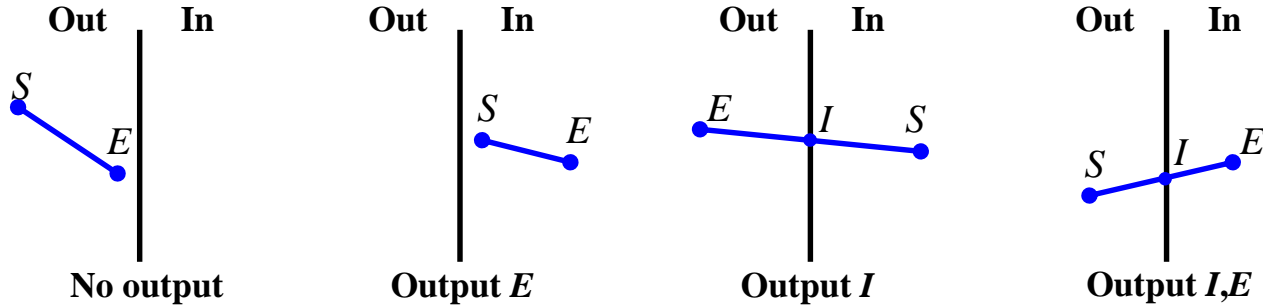

Sutherland-Hodgman Algorithm

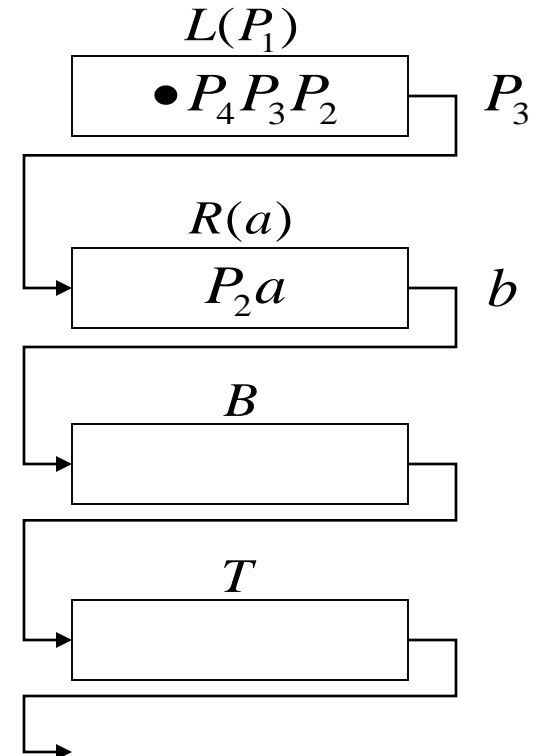
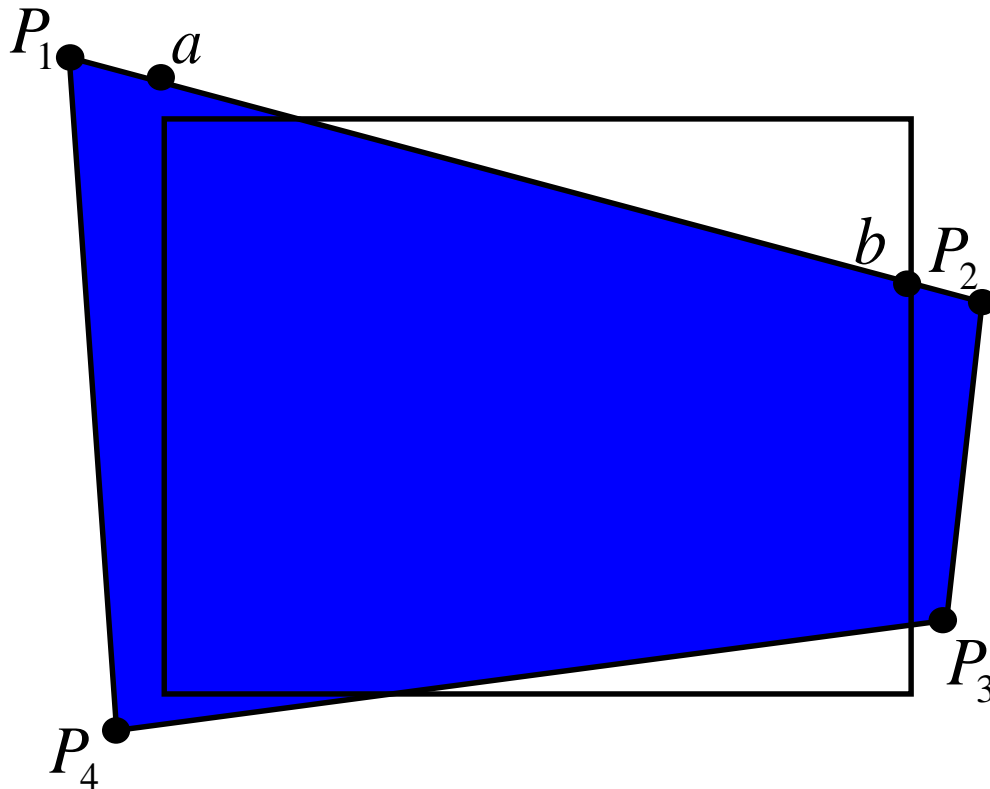
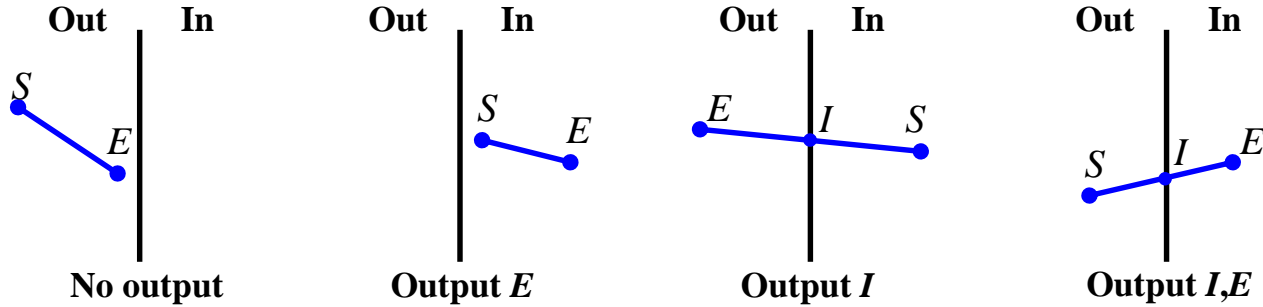

Sutherland-Hodgman Algorithm

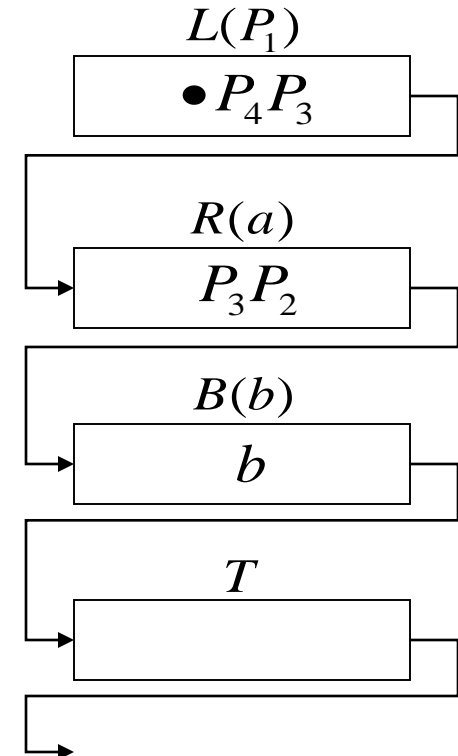
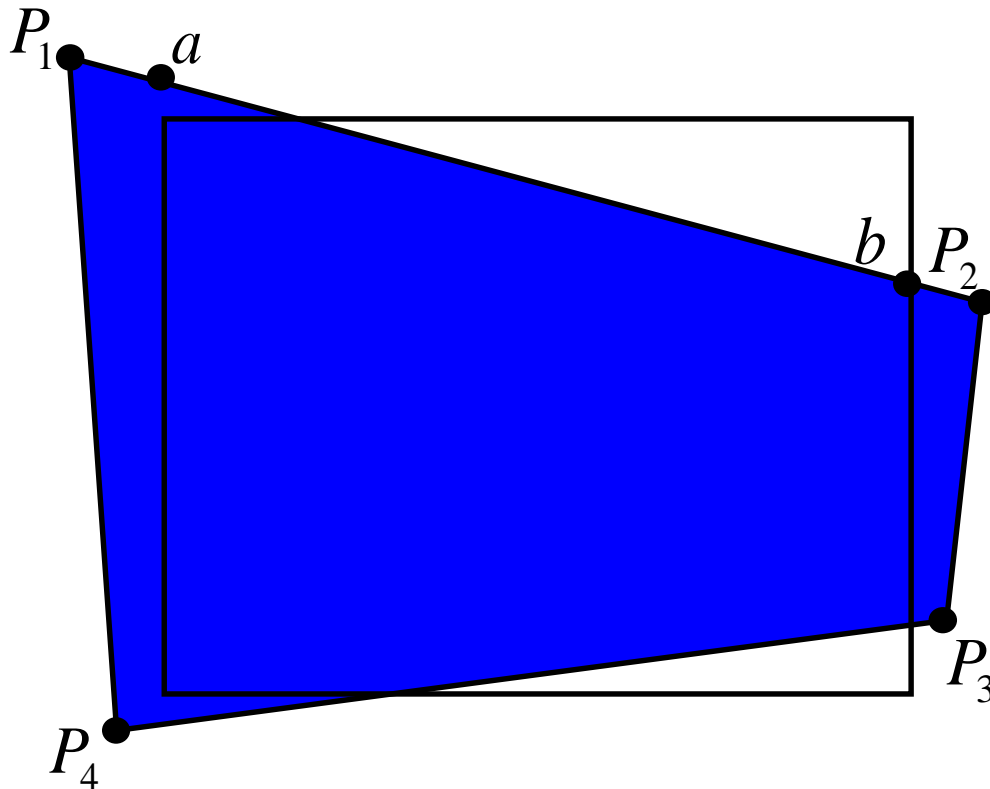
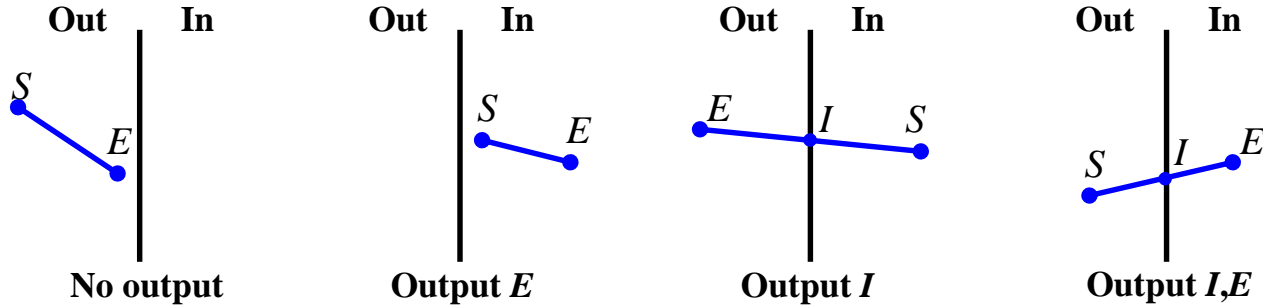

Sutherland-Hodgman Algorithm

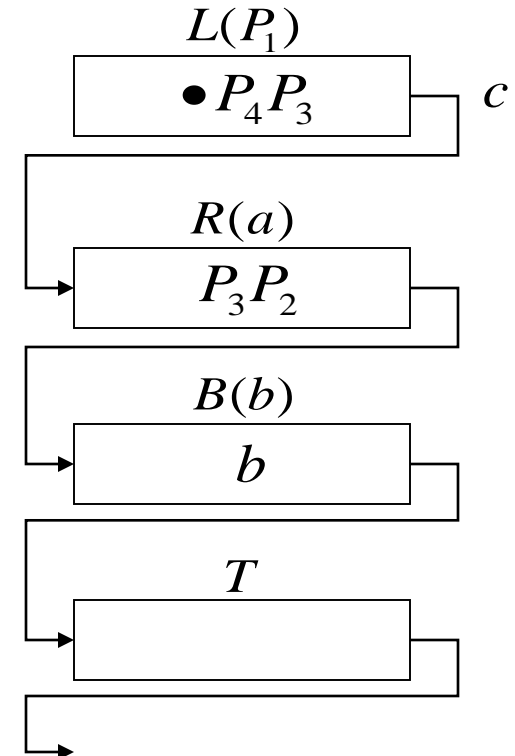
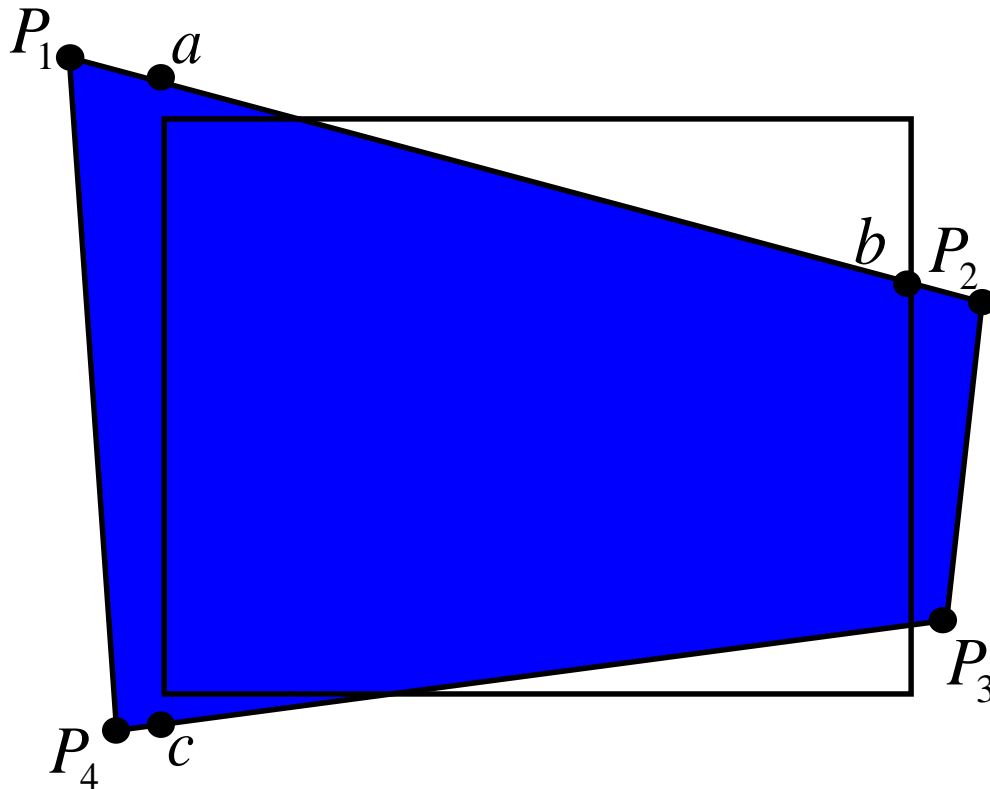
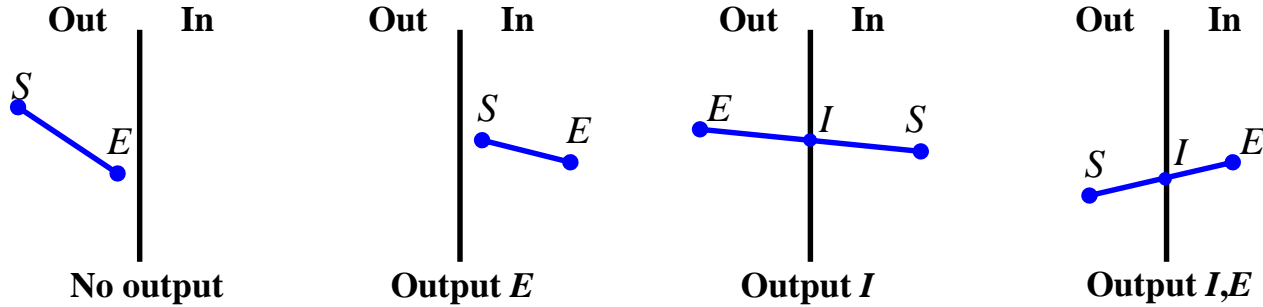

Sutherland-Hodgman Algorithm

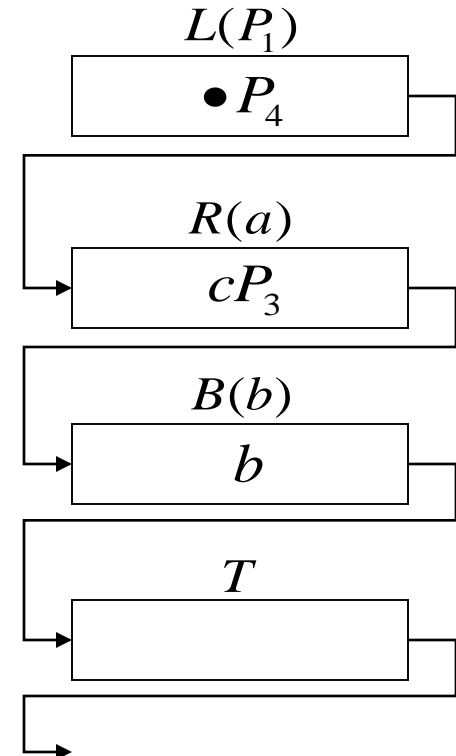
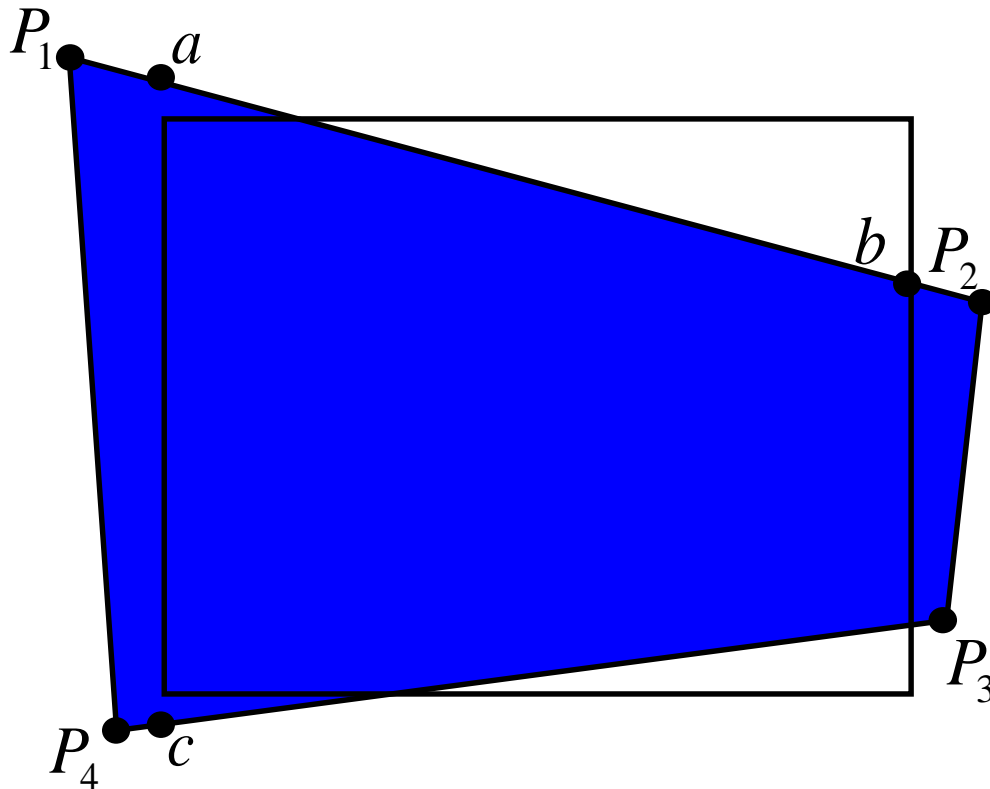
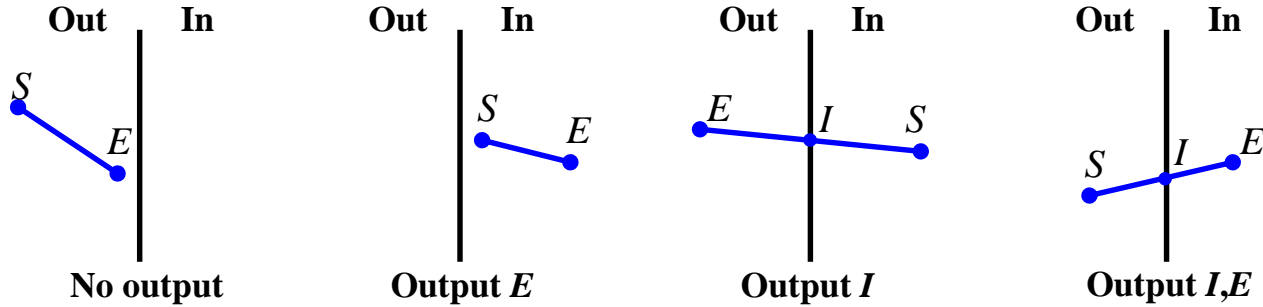

Sutherland-Hodgman Algorithm

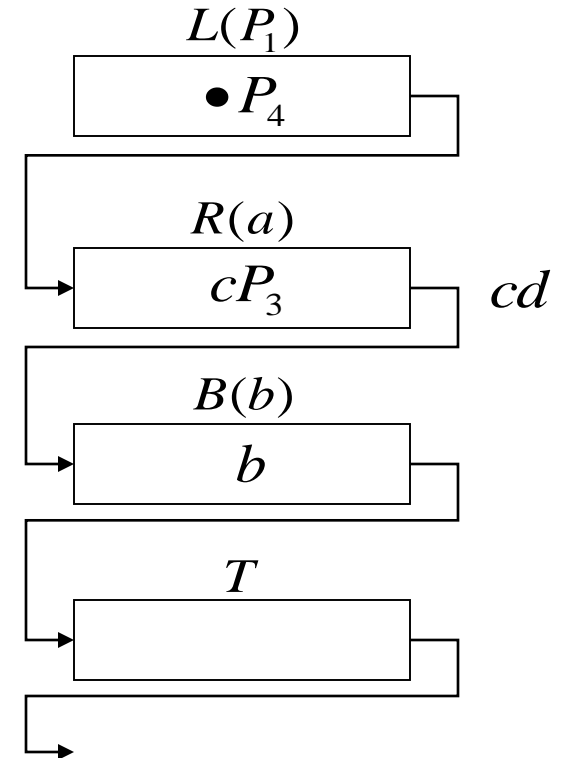
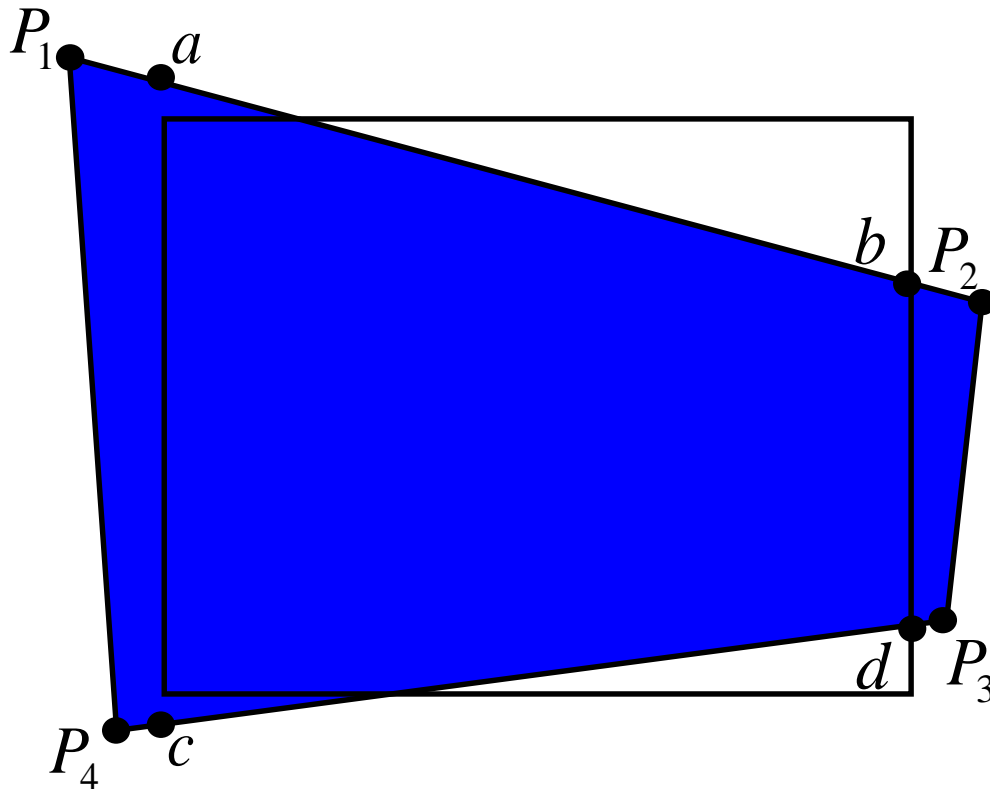
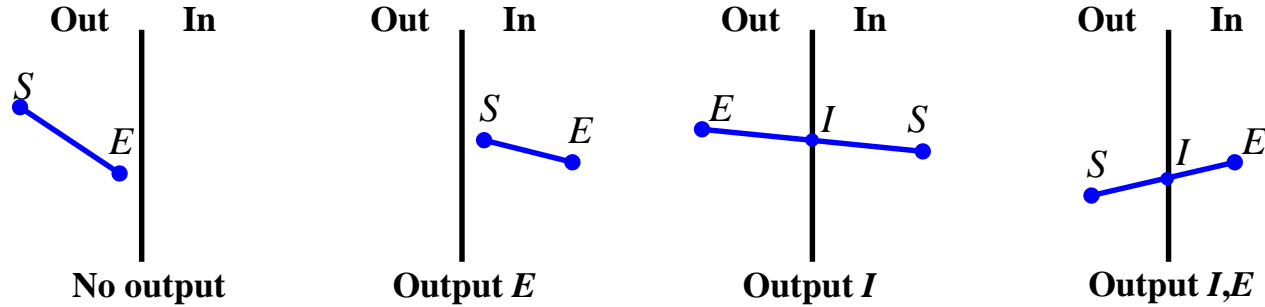

Sutherland-Hodgman Algorithm

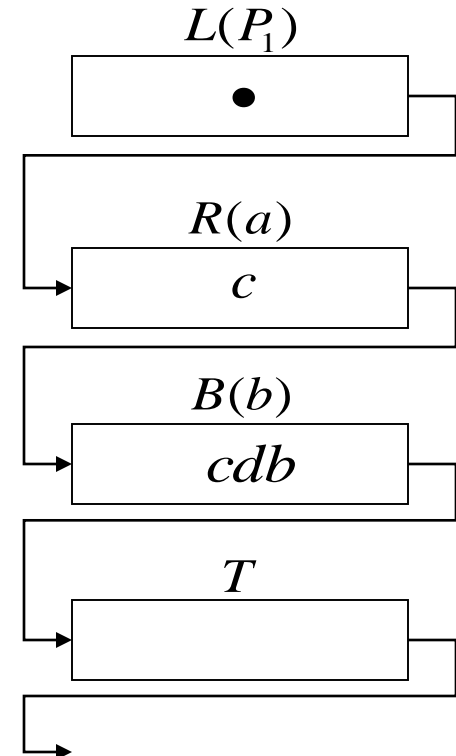
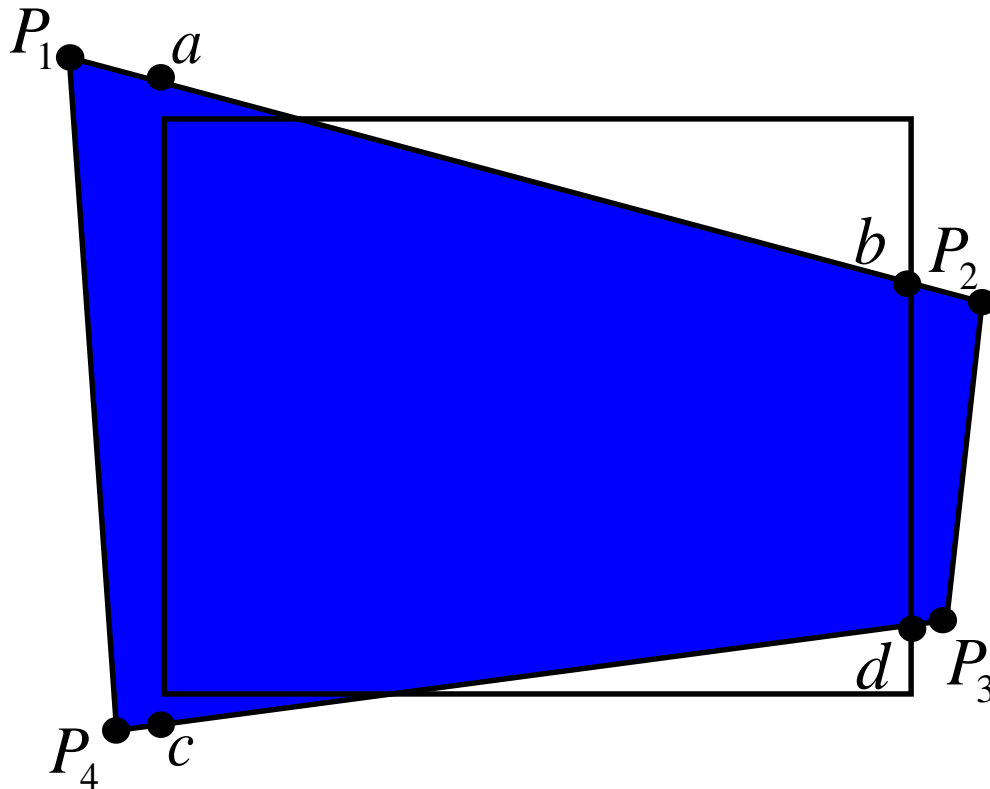
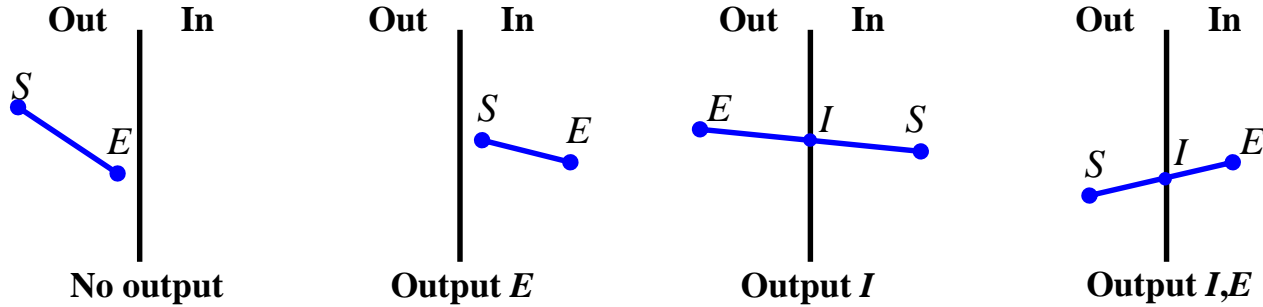

Sutherland-Hodgman Algorithm

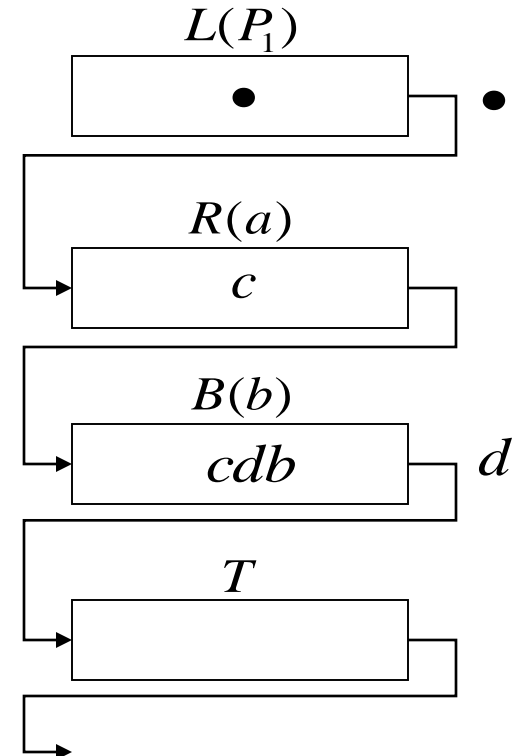
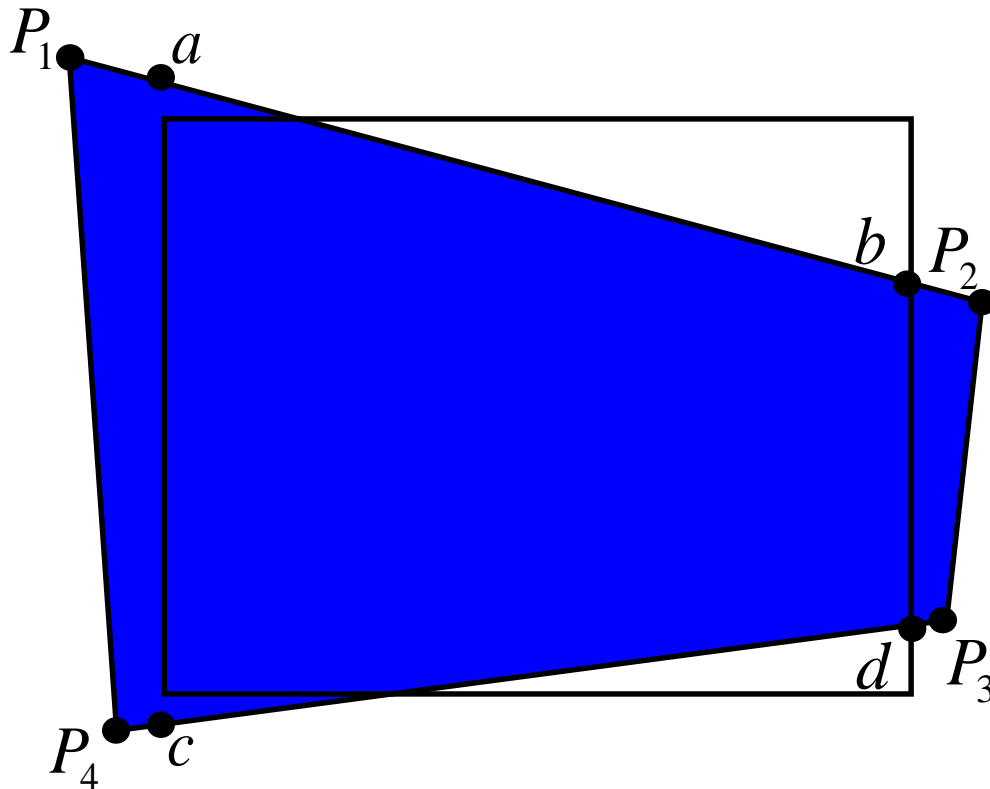
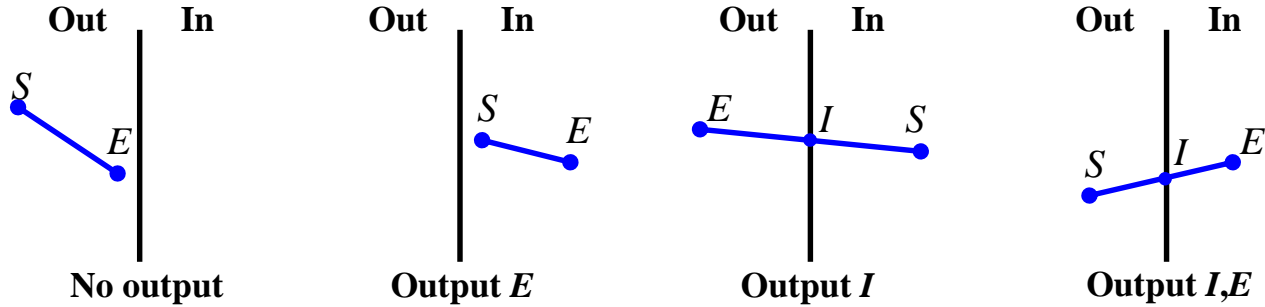

Sutherland-Hodgman Algorithm

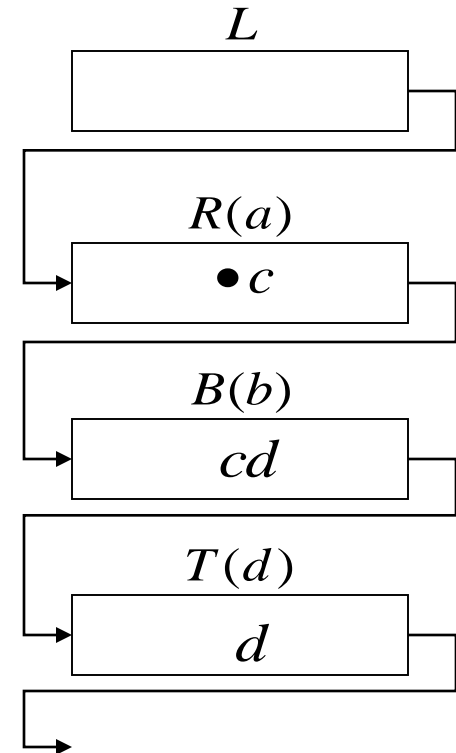
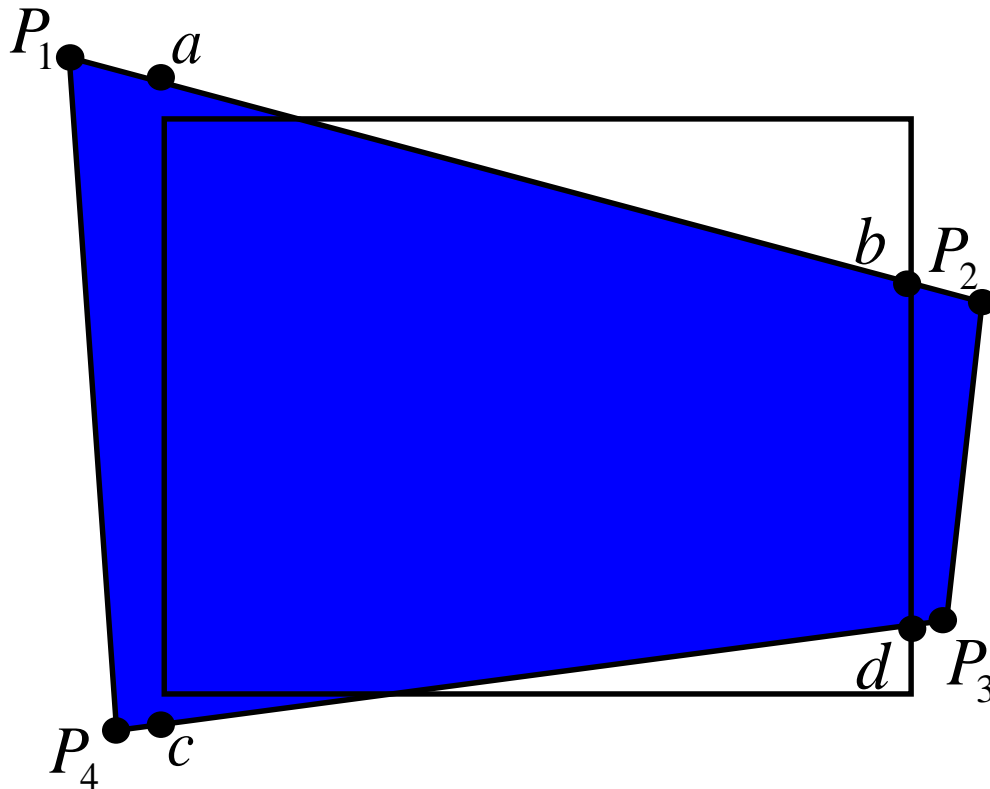
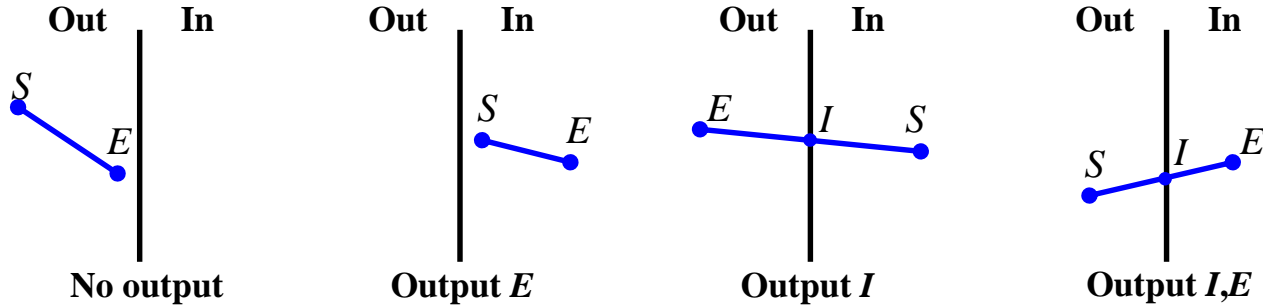

Sutherland-Hodgman Algorithm

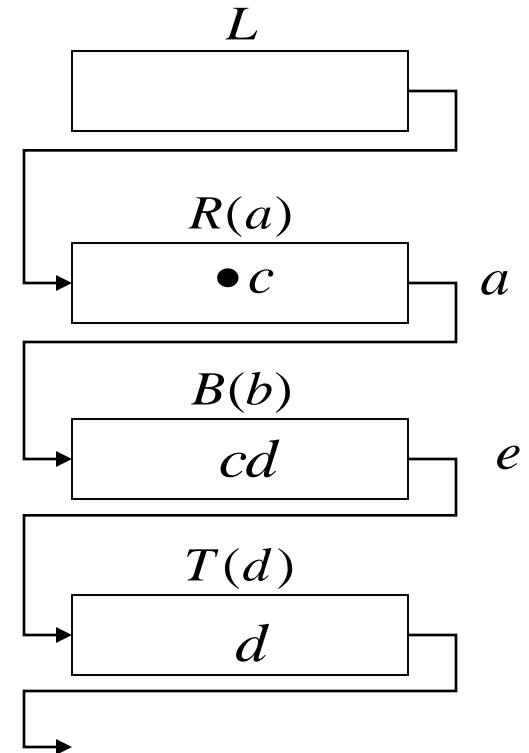
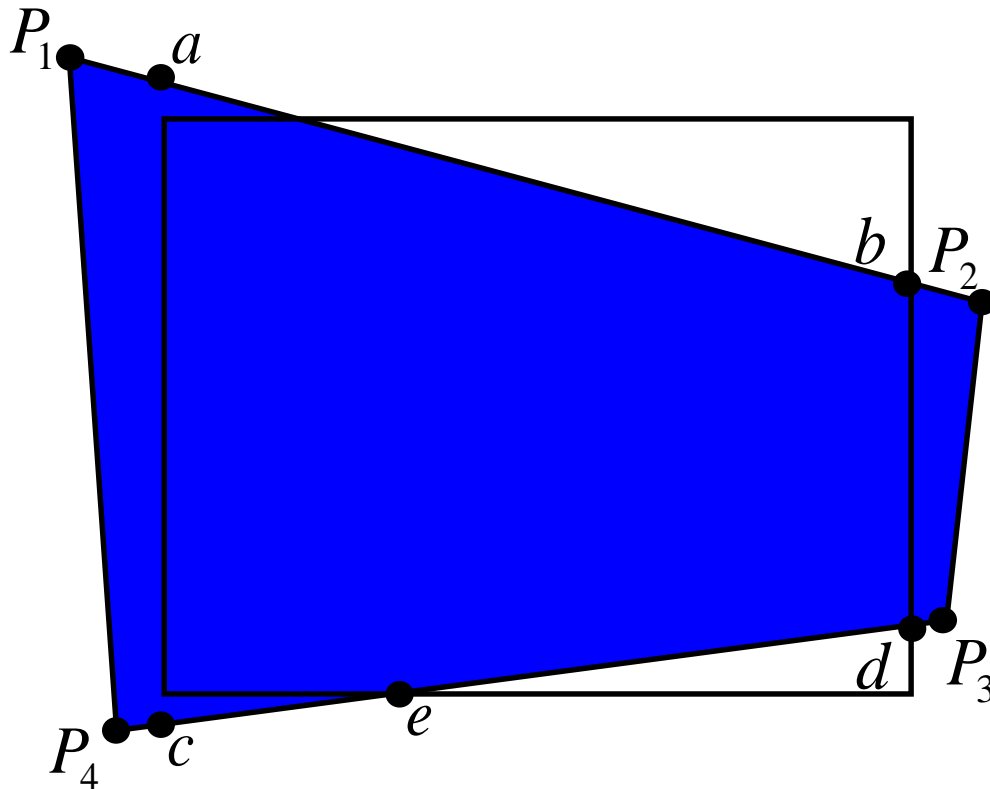
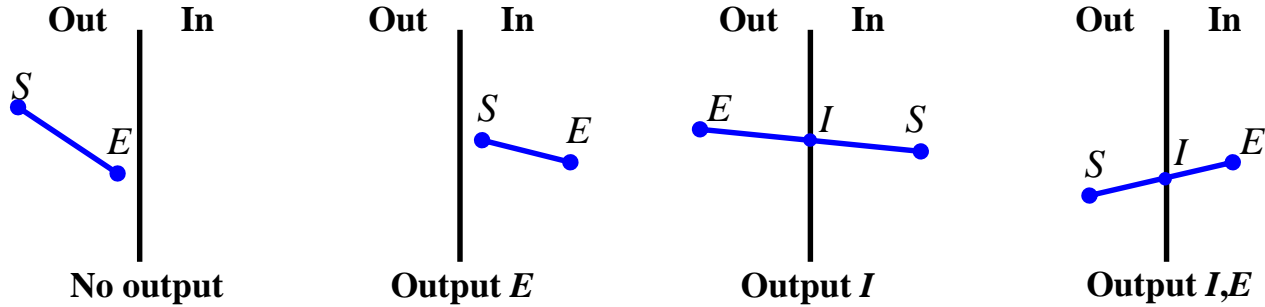

Sutherland-Hodgman Algorithm

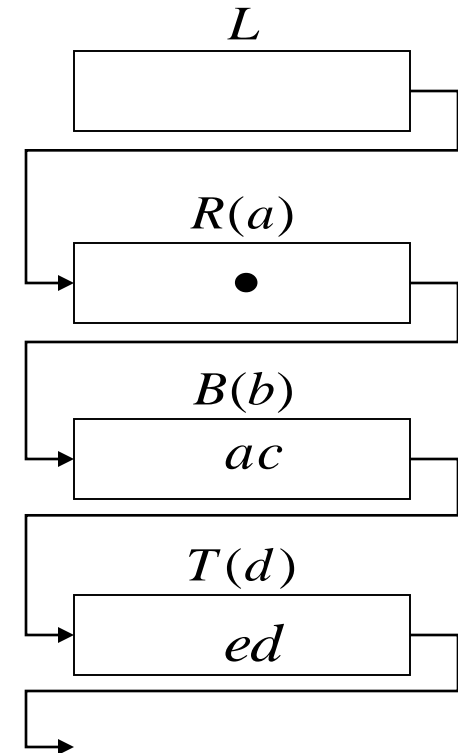
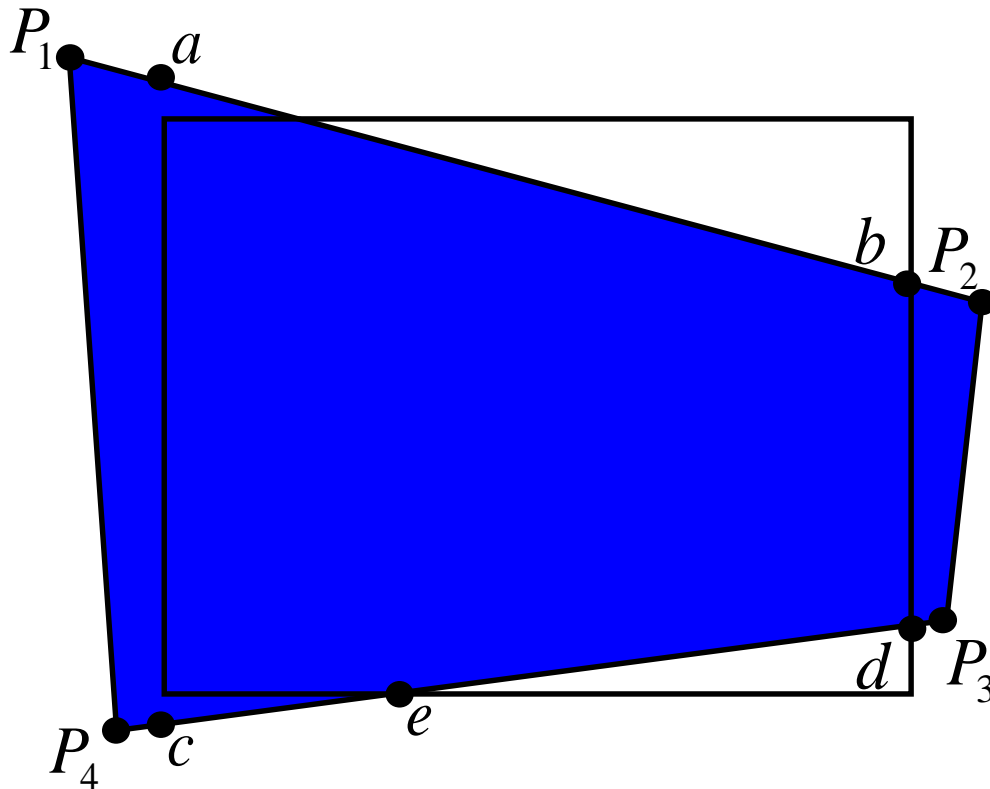
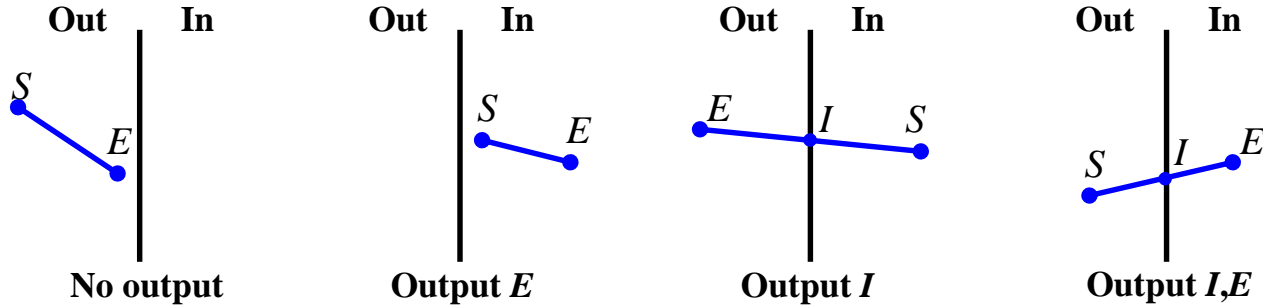

Sutherland-Hodgman Algorithm

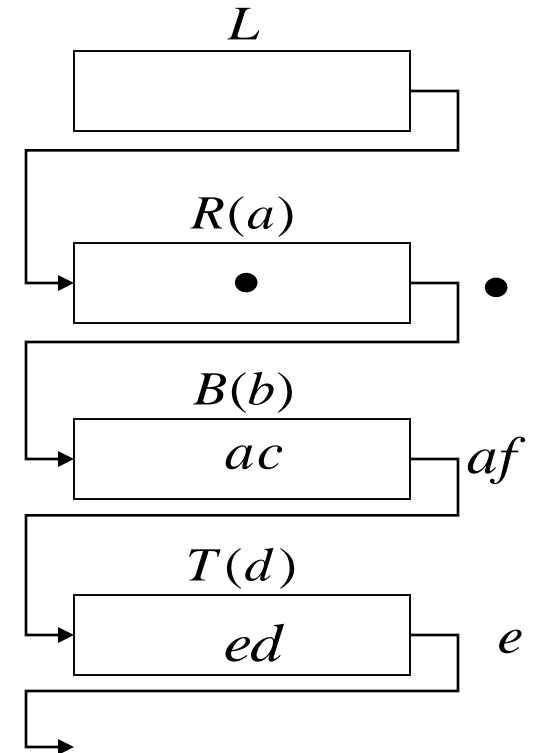
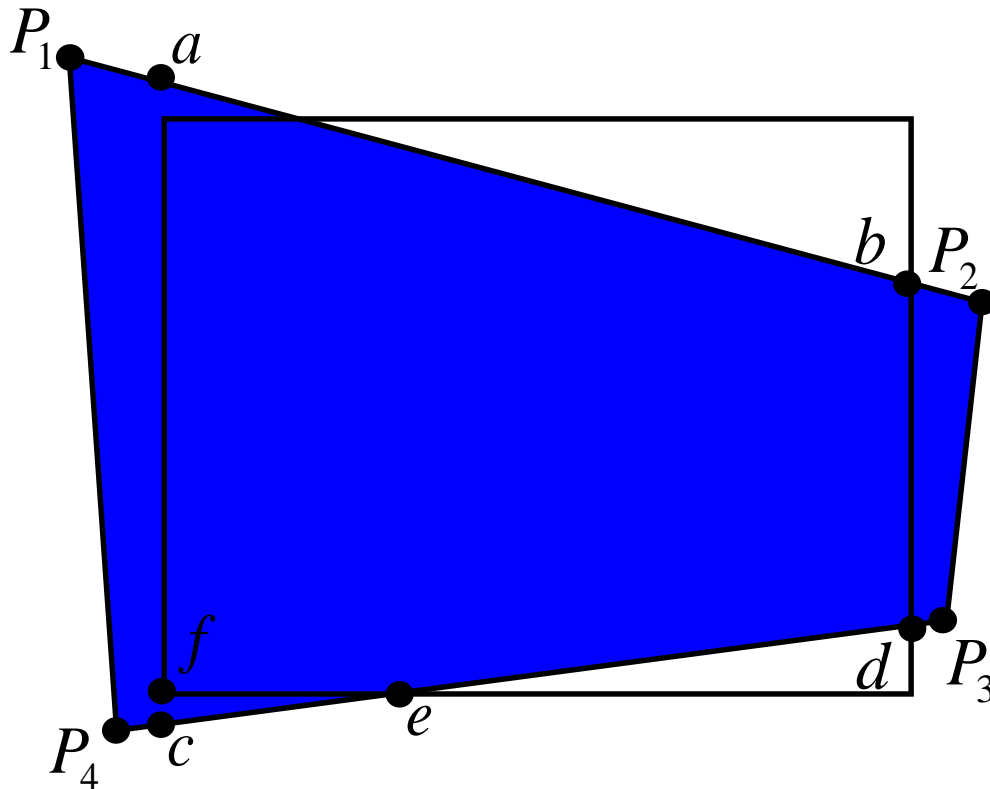
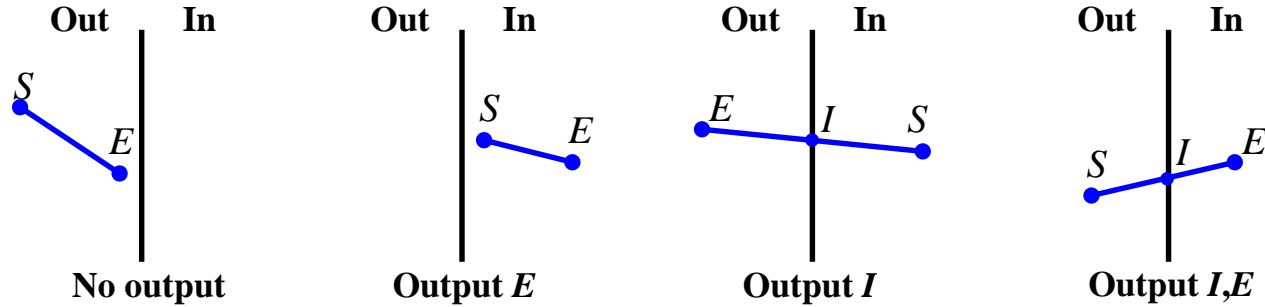

Sutherland-Hodgman Algorithm

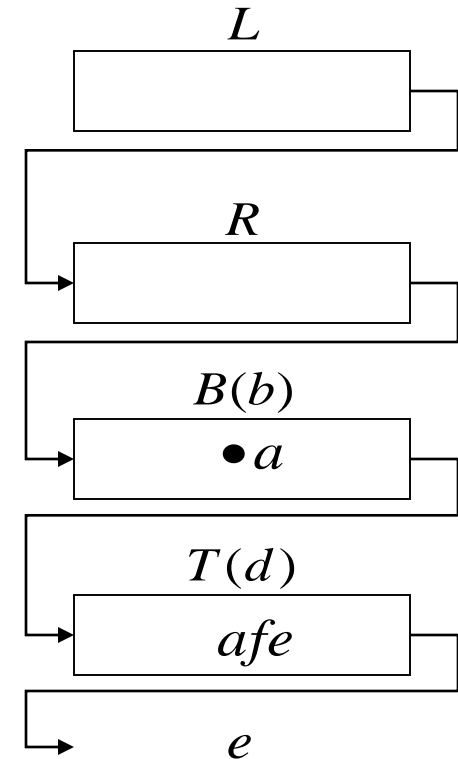
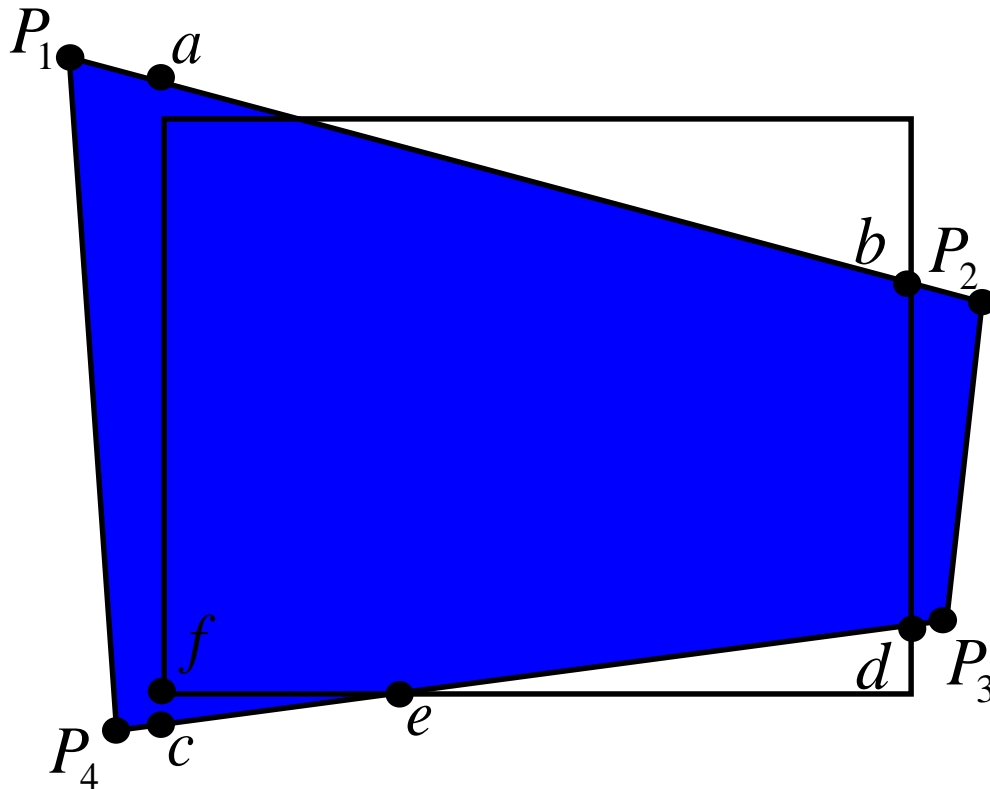
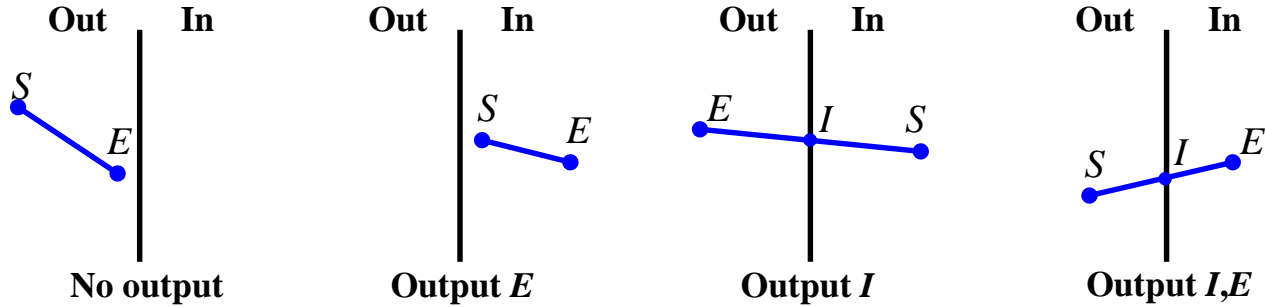

Sutherland-Hodgman Algorithm

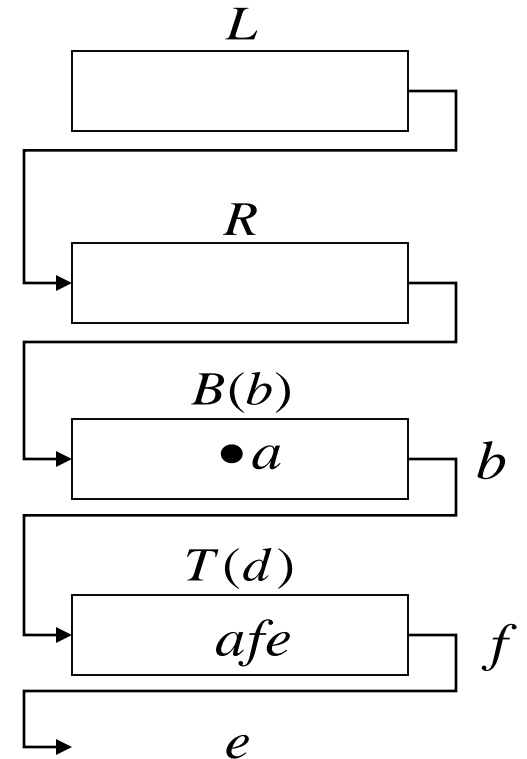
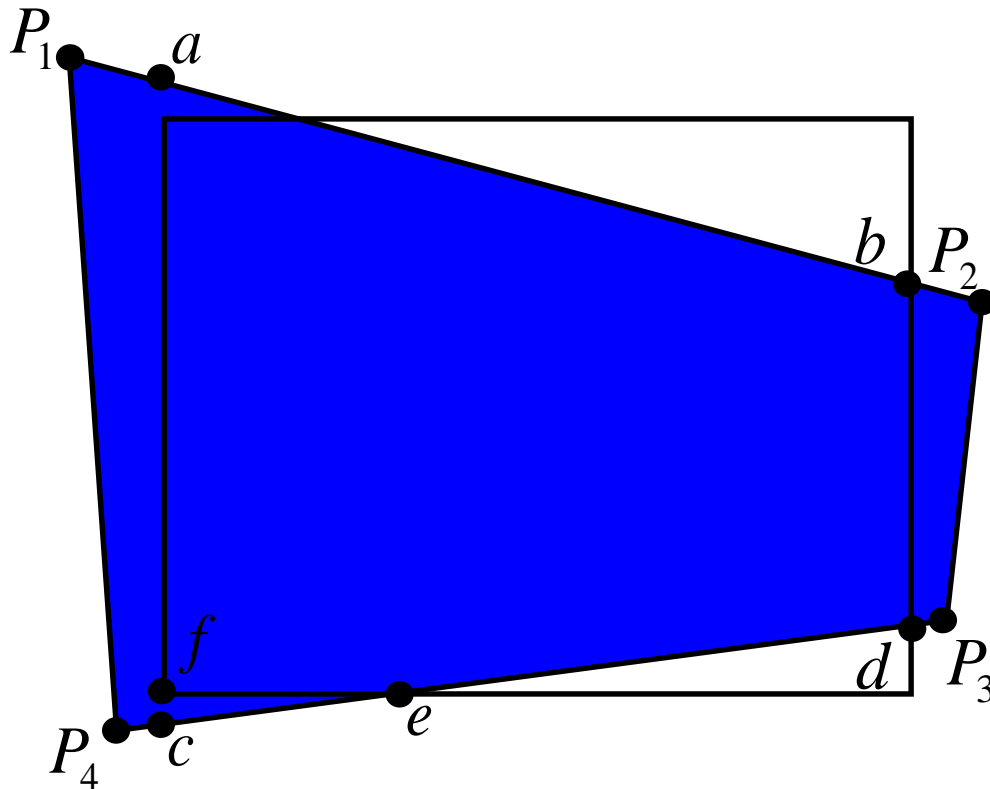
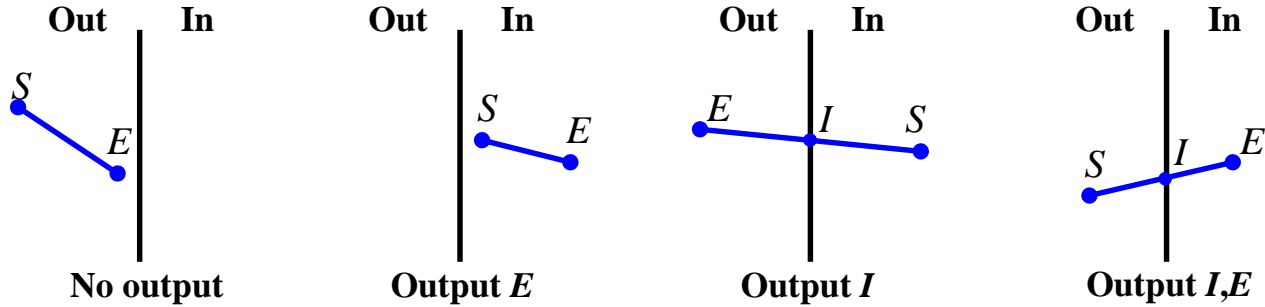

Sutherland-Hodgman Algorithm

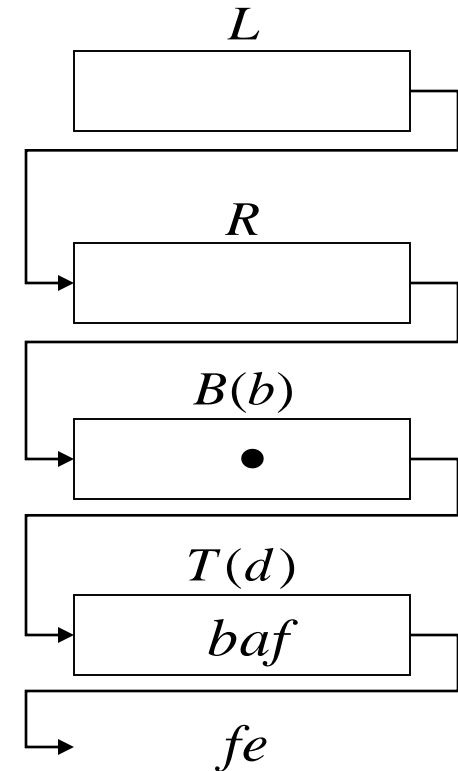
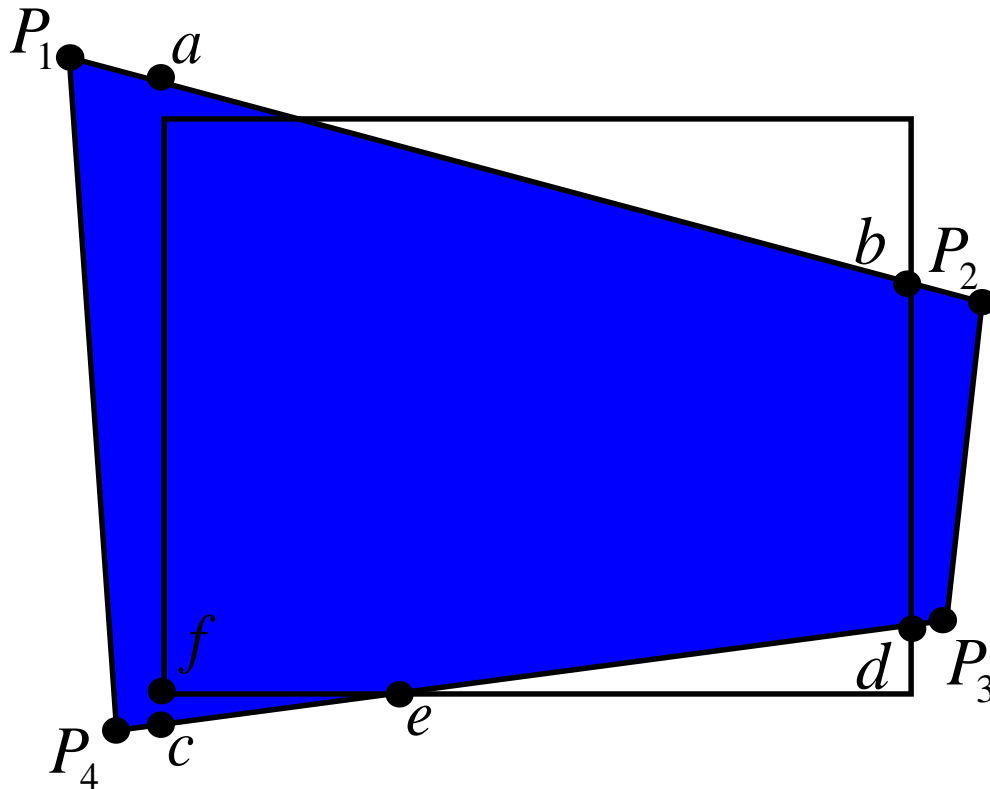
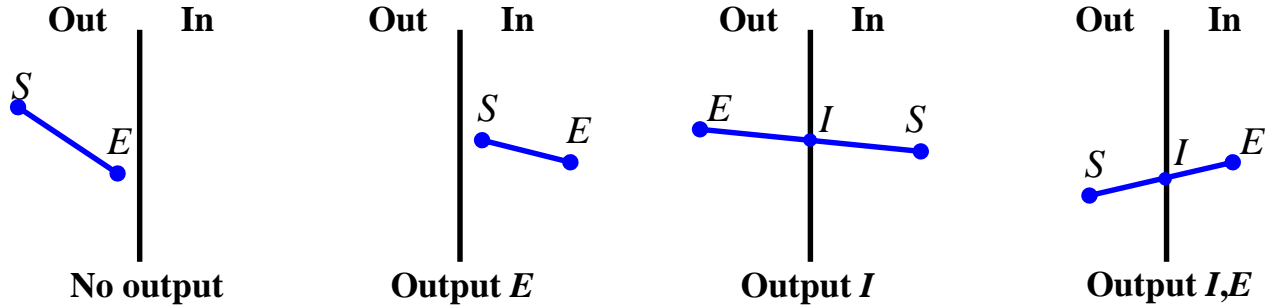

Sutherland-Hodgman Algorithm

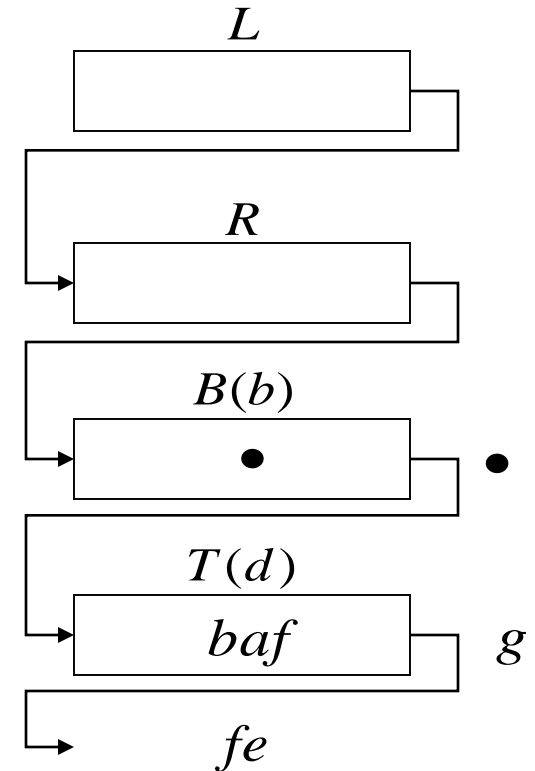
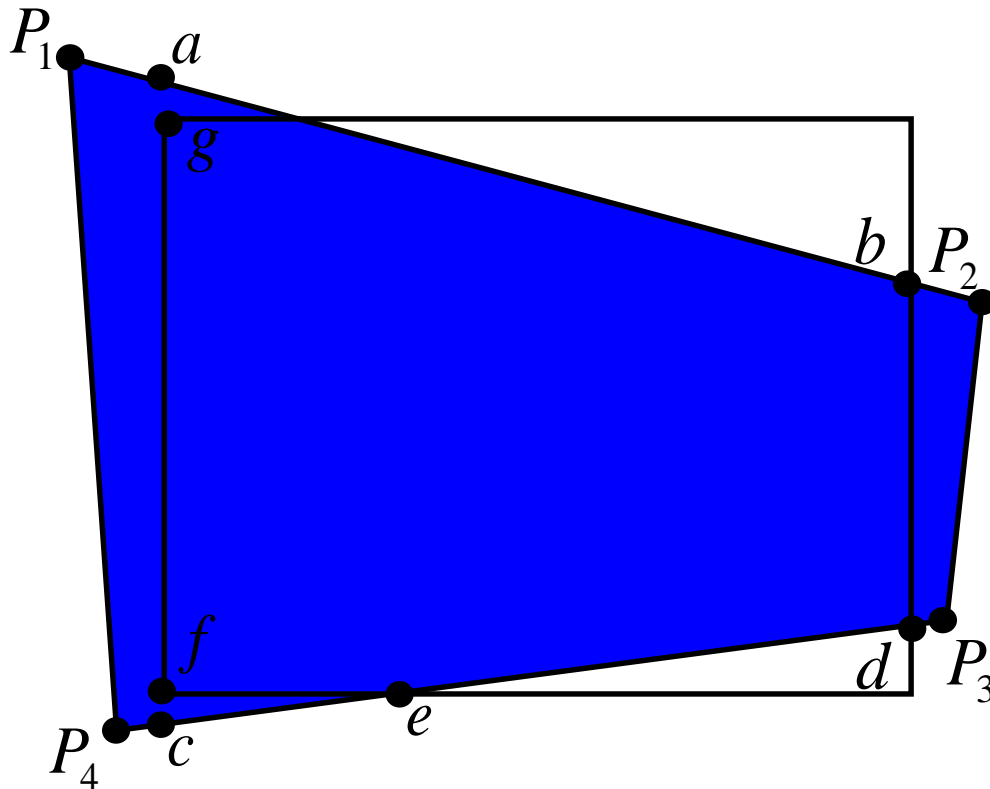
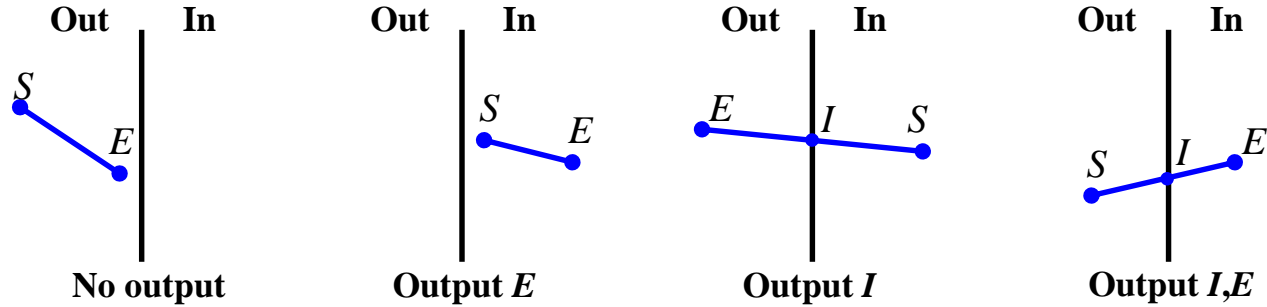

Sutherland-Hodgman Algorithm

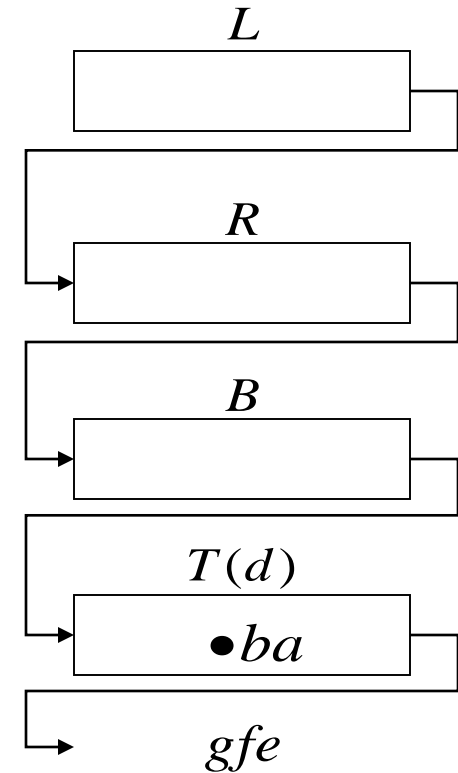
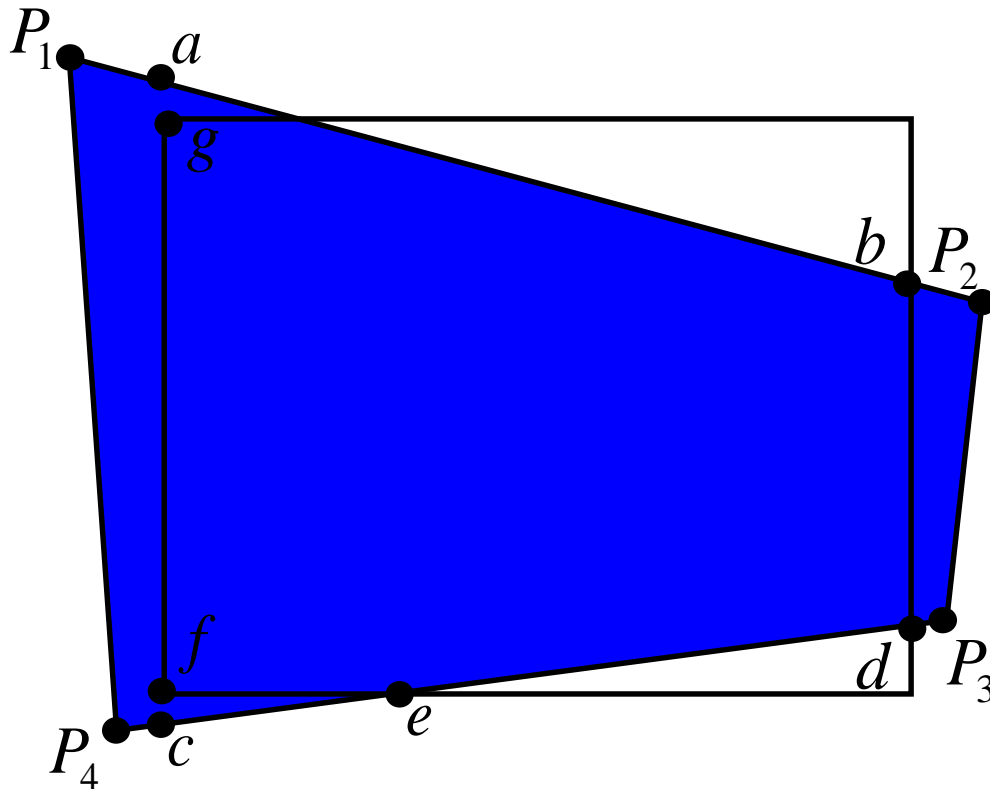
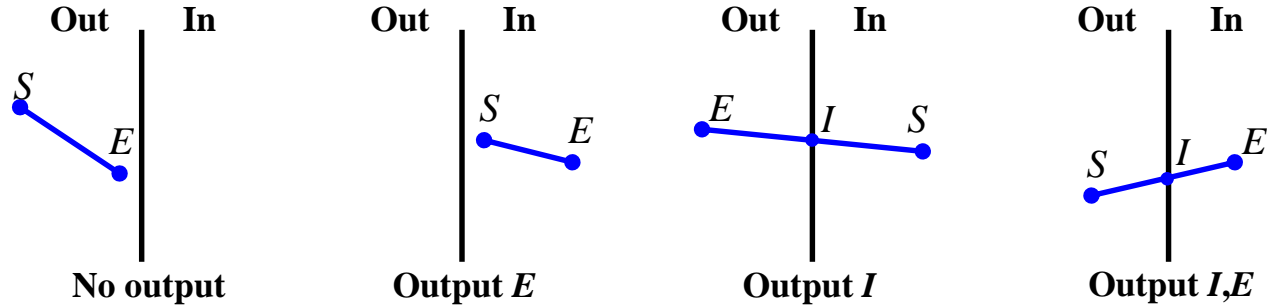

Sutherland-Hodgman Algorithm

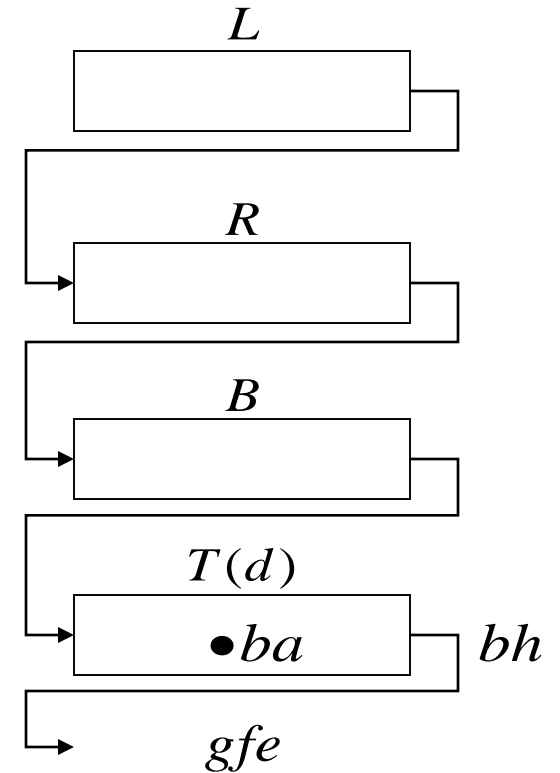
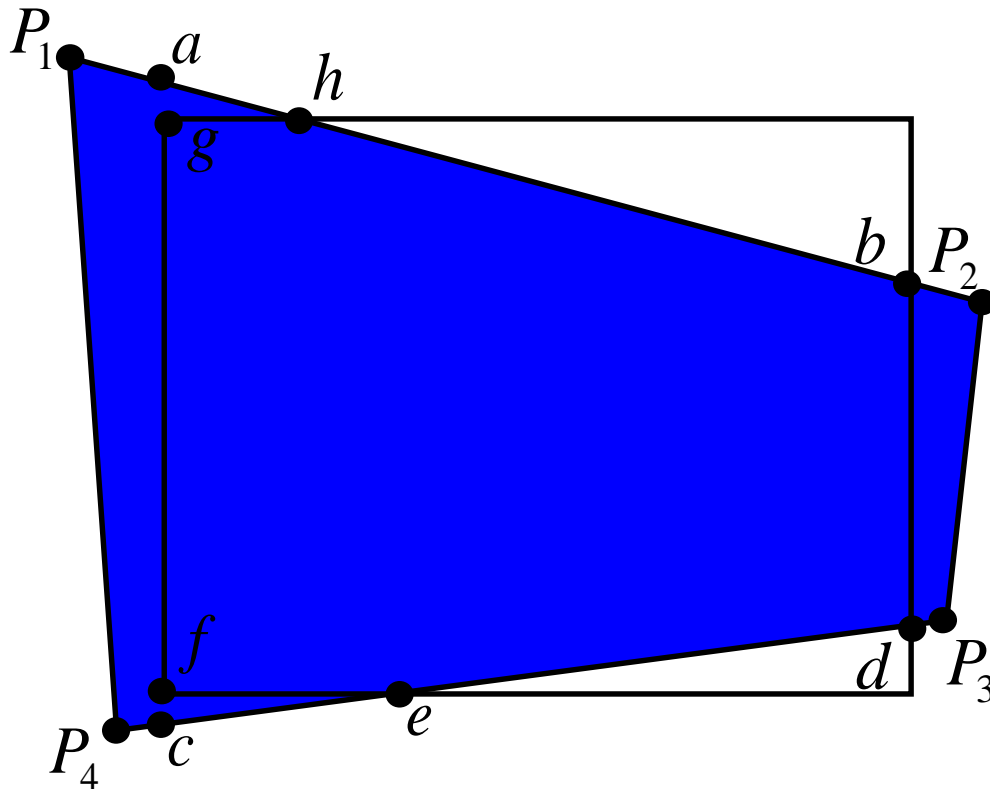
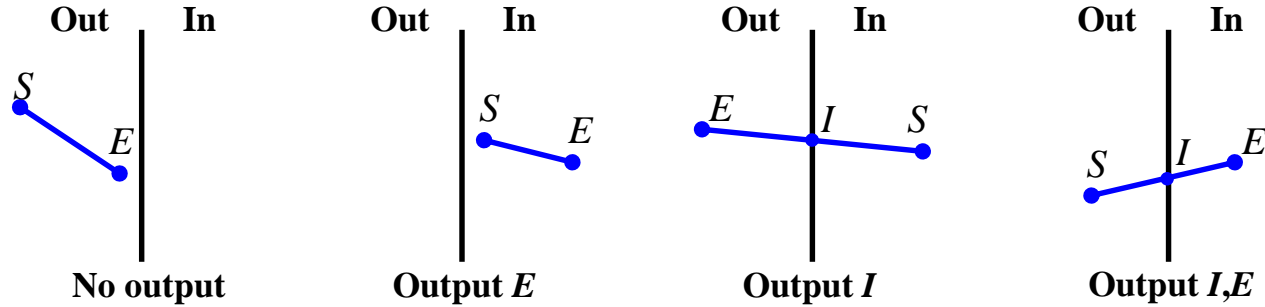

Sutherland-Hodgman Algorithm

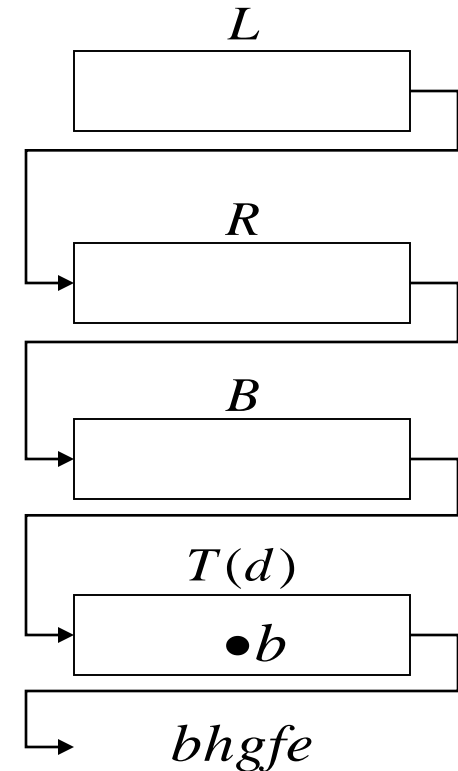
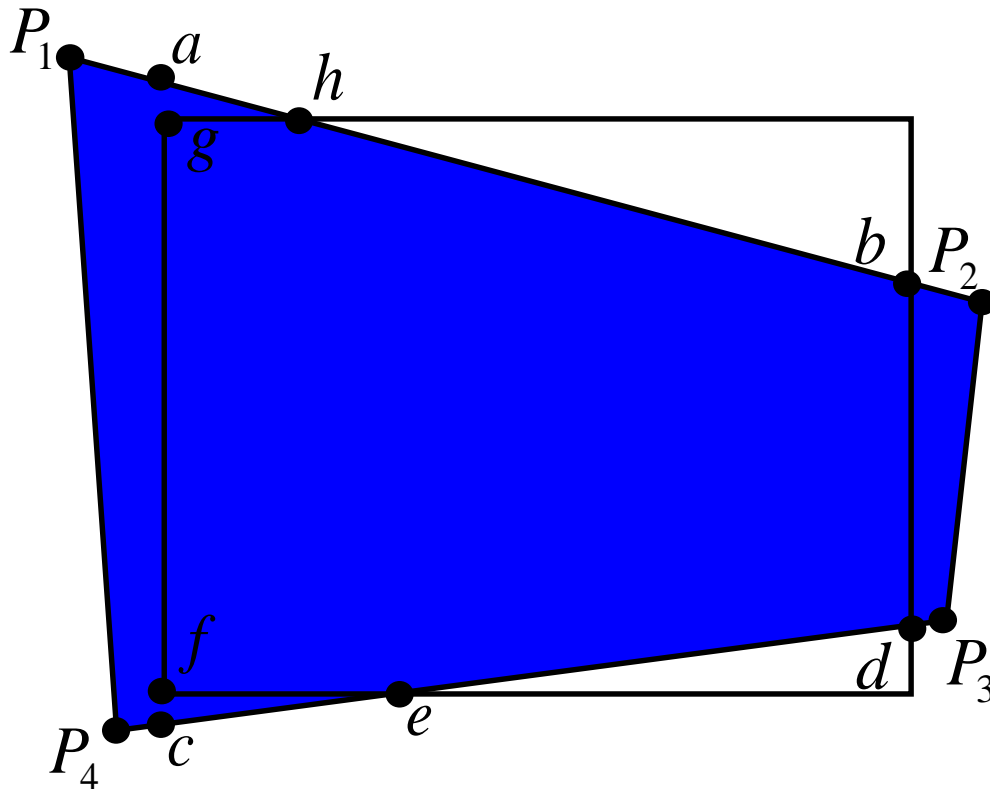
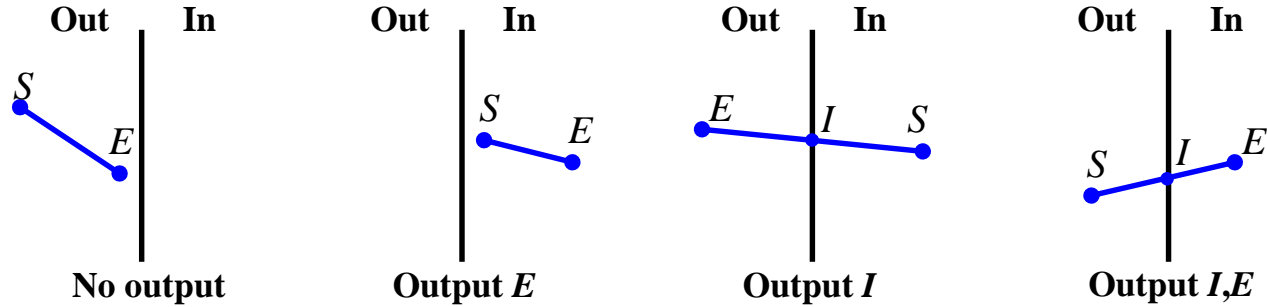

Sutherland-Hodgman Algorithm

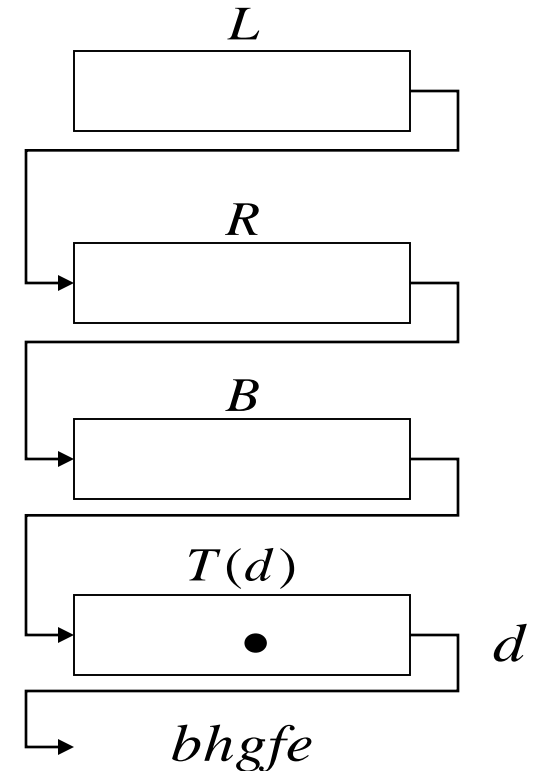
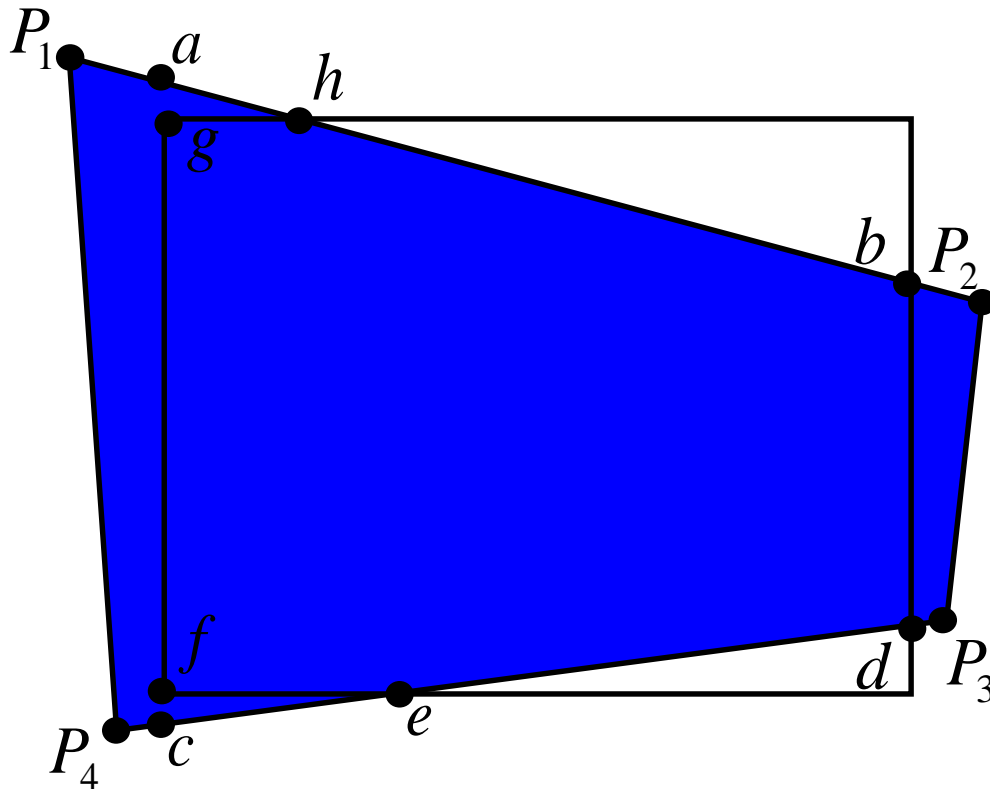
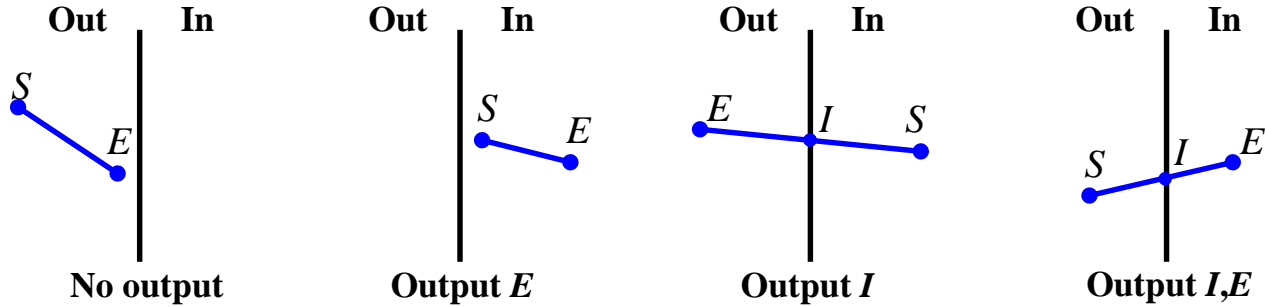

Sutherland-Hodgman Algorithm

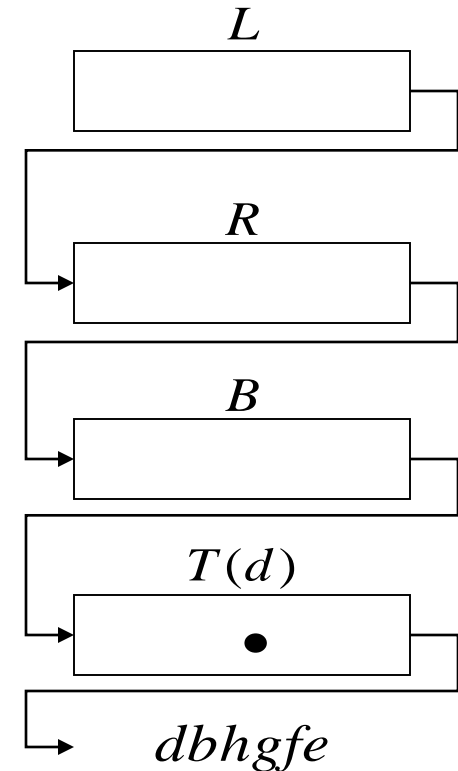
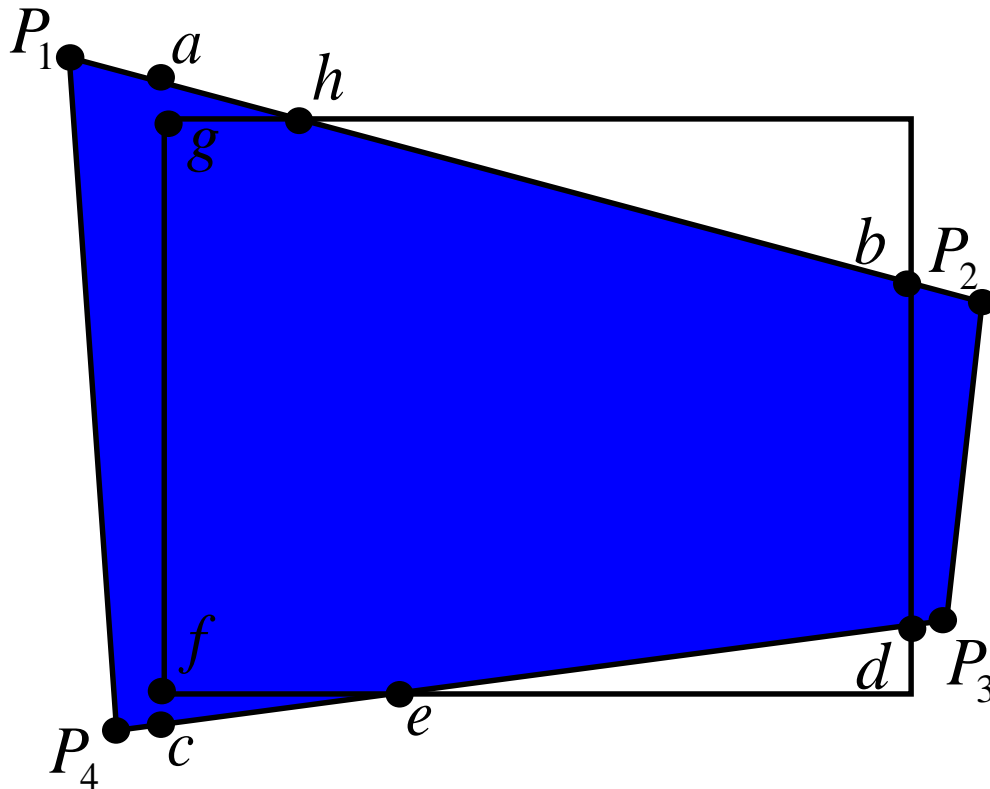
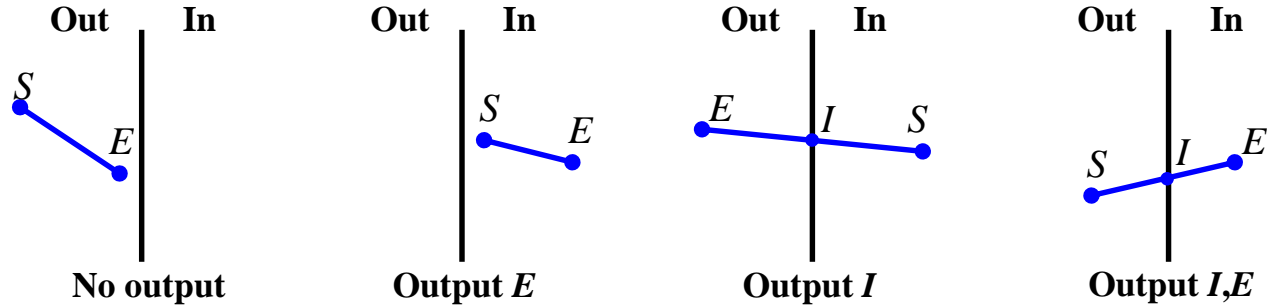

Sutherland-Hodgman Algorithm

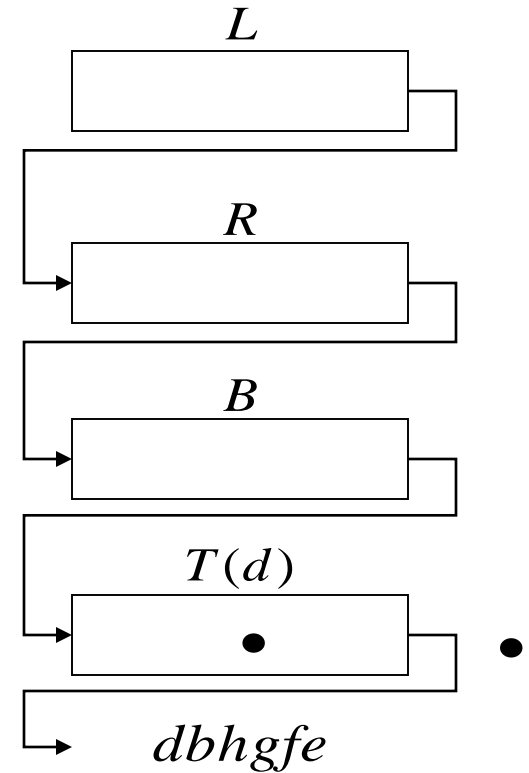
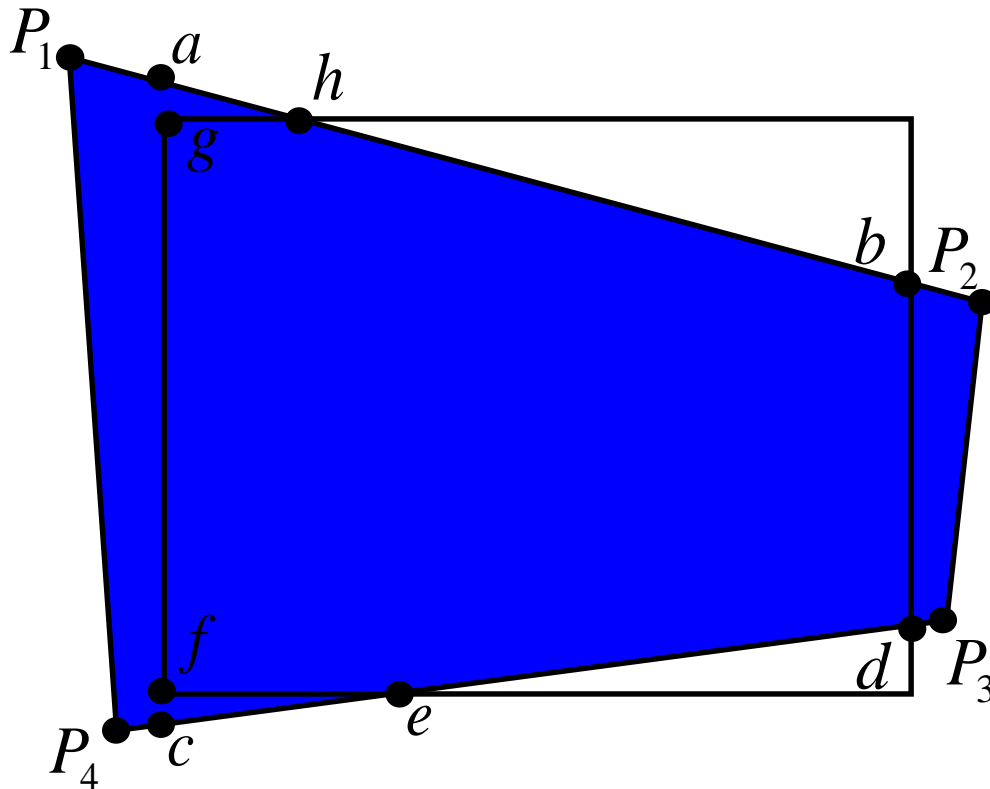
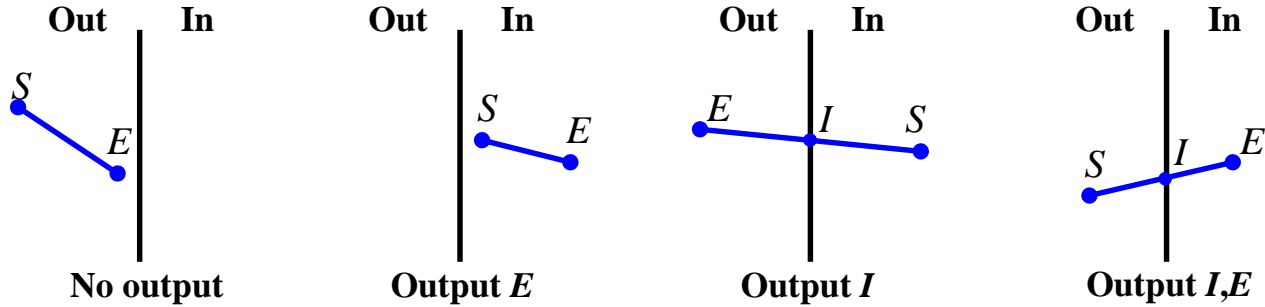

Sutherland-Hodgman Algorithm

